

MFX-C2500

Multi Functional Printer User's Guide

features of your new laser product

Your new machine is equipped with a number of special features that improve the quality of the documents you print. With the machine, you can:

SPECIAL FEATURES



Print with excellent quality and speed

- You can print in a full range of colors using cyan, magenta, yellow, and black.
- You can print with a resolution of up to 2400 x 600 dpi. See *Software section*.
- Your machine prints A4-sized paper at up to 24 ppm and letter-sized paper at up to 25 ppm.

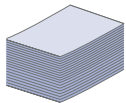

Handle many different types of printable material

- The multi-purpose tray supports letterhead, envelopes, labels, custom-sized media, postcards, and heavy paper. The multi-purpose tray holds up to 100 sheets of plain paper.
- The 250-sheet tray 1 and 500-sheet optional tray support plain paper in various sizes.

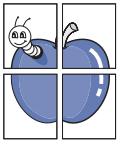

Create professional documents

- Print Watermarks. You can customize your documents with words, such as "Confidential". See *Software section*.
- Print Posters. The text and pictures of each page of your document are magnified and printed across the sheet of paper and can then be taped together to form a poster. See *Software section*.
- You can use preprinted forms and letterhead with plain paper. See *Software section*.



Save time and money

- To save paper, you can print multiple pages on one single sheet of paper.
- This machine automatically conserves electricity by substantially reducing power consumption when not in use.
- To save paper, you can print on both sides of the paper (double-sided printing). See *Software section*.

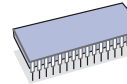

Expand your machine's capacity

- Your machine has an extra memory slot to expand their memory. (Page 90)
- Zoran IPS Emulation* compatible with PostScript 3 (PS) enables PS printing.

ZORAN * Zoran IPS Emulation compatible with PostScript 3

© Copyright 1995-2005, Zoran Corporation. All rights reserved. Zoran, the Zoran logo, IPS/PS3, and OneImage are trademarks of Zoran Corporation.

* 136 PS3 fonts

Contains UFST and MicroType from Monotype Imaging Inc.



Print in various environments

- You can print with Windows 2000 and Windows XP/2003/ Vista as well as Linux and Macintosh systems.
- Your machine is equipped with a USB interface and a network interface.

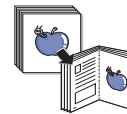

Copy originals in several formats

- Your machine can print multiple image copies from the original document on a single page.
- There are special functions to erase catalog and newspaper background.
- The print quality and image size may be adjusted and enhanced at the same time.

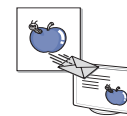

Scan the originals and send it right away

- Scan in color and use the precise compressions of JPEG, TIFF and PDF formats.
- Quickly scan and send files to multiple destinations using Networks scanning.

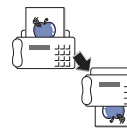

Set a specific time to transmit a Fax

- You can specify a certain time to transmit the fax and also send the fax to several stored destinations.
- After the transmission, the machine may print out the fax reports according to the setting.



ABOUT THIS USER'S GUIDE

This user's guide provides information about basic understanding of the machine as well as detailed explanation on each step during the actual usage. Both novice users and professional users can refer to this guide for installing and using the machine.

Some terms in this guide are used interchangeably, as below:

- Document is synonymous with original.
- Paper is synonymous with media, or print media.

Following table offers the conventions of this guide:

CONVENTION	DESCRIPTION	EXAMPLE
Bold	Used for texts on the display or actual prints on the machine.	Start
Note	Used to provide additional information or detailed specification of the machine function and feature.	 The date format may differ from country to country
Caution	Used to give users information to protect the machine from possible mechanical damage or malfunction.	 Do not touch the green underside of the toner cartridge.
Footnote	Used to provide more detailed information on certain words or a phrase.	a. pages per minute
(See page 1 for more information)	Used to guide users to the reference page for the additional detailed information.	(See page 1 for more information)





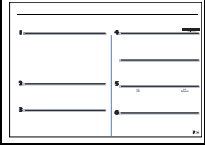
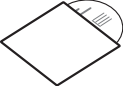
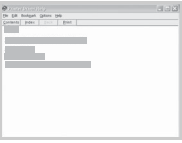





FINDING MORE INFORMATION

You can find information for setting up and using your machine from the following resources, either as a print-out or onscreen.















<p>Quick Install Guide</p> 	<p>Provides information on setting up your machine and this requires that you follow the instructions in the guide to prepare the machine.</p>
<p>Online User's Guide</p> 	<p>Provides you with step-by-step instructions for using your machine's full features, and contains information for maintaining your machine, troubleshooting, and installing accessories. This user's guide also contains a <i>Software section</i> to provide you with information on how to print documents with your machine in various operating systems, and how to use the included software utilities.</p>
<p>Printer Driver Help</p> 	<p>Provides you with help information on printer driver properties and instructions for setting up the properties for printing. To access a printer driver help screen, click Help from the printer properties dialog box.</p>
	<p>_____</p>





IMPORTANT SAFETY SYMBOLS AND PRECAUTIONS

What the icons and signs in this user's guide mean:

 WARNING	Hazards or unsafe practices that may result in severe personal injury or death.
 CAUTION	Hazards or unsafe practices that may result in minor personal injury or property damage.
 CAUTION	To reduce the risk of fire, explosion, electric shock, or personal injury when using your laser MFP, follow these basic safety precautions:
	Do NOT attempt.
	Do NOT disassemble.
	Do NOT touch.
	Follow directions explicitly.
	Unplug the power plug from the wall socket.
	Make sure the MFP is grounded to prevent electric shock.
	Call the service center for help.

These warning signs are here to prevent injury to you and others. Follow them explicitly. After reading this section, keep it in a safe place for future reference.

-  1. Read and understand all instructions.
-  2. Use common sense whenever operating electrical appliances.
-  3. Follow all warnings and instructions marked on the machine and in the literature accompanying the machine.
-  4. If an operating instruction appears to conflict with safety information, heed the safety information. You may have misunderstood the operating instruction. If you cannot resolve the conflict, contact your sales or service representative for assistance.
-  5. Unplug the machine from the AC wall socket and/or telephone jack before cleaning. Do not use liquid or aerosol cleaners. Use only a damp cloth for cleaning.
-  6. Do not place the machine on an unstable cart, stand or table. It may fall, causing serious damage.
-  7. Your machine should never be placed on, near or over a radiator, heater, air conditioner or ventilation duct.
-  8. Do not allow anything to rest on the power. Do not locate your machine where the cords will be abused by persons walking on them.
-  9. Do not overload wall outlets and extension cords. This can diminish performance, and may result in the risk of fire or electric shock.
-  10. Do not allow pets to chew on the AC power, telephone or PC interface cords.
-  11. Never push objects of any kind into the machine through case or cabinet openings. They may touch dangerous voltage points, creating a risk of fire or shock. Never spill liquid of any kind onto or into the machine.
-    12. To reduce the risk of electric shock, do not disassemble the machine. Take it to a qualified service technician when repair work is required. Opening or removing covers may expose you to dangerous voltages or other risks. Incorrect reassembly could cause electric shock when the unit is subsequently used.

-  **13.** Unplug the machine from the telephone jack, PC and AC wall outlet and refer servicing to qualified service personnel under the following conditions:
- When any part of the power cord, plug or connecting cable is damaged or frayed.
 - If liquid has been spilled into the machine.
 - If the machine has been exposed to rain or water.
 - If the machine does not operate properly after instructions have been followed.
 - If the machine has been dropped, or the cabinet appears damaged.
 - If the machine exhibits a sudden and distinct change in performance.
-  **14.** Adjust only those controls covered by the operating instructions. Improper adjustment of other controls may result in damage, and may require extensive work by a qualified service technician to restore the machine to normal operation.
-  **15.** Avoid using this machine during a lightning storm. There may be a remote risk of electric shock from lightning. If possible, unplug the AC power and telephone cord for the duration of the lightning storm.
- 16.** The Power cord supplied with your machine should be used for safe operation. If you are using a cord which is longer than 2 m with 110 V machine, then it should be 16 AWG^a or bigger.
- 17.** Use only No.26 AWG or larger telephone line cord.
-  **18.** SAVE THESE INSTRUCTIONS
- 19.** This machine can be operated only in the country you have purchased. (Due to different voltage, frequency, telecommunication configuration and etc)

a. AWG: American Wire Gauge

LASER SAFETY STATEMENT

The printer is certified in the U.S. to conform to the requirements of DHHS 21 CFR, chapter 1 Subchapter J for Class I(1) laser products, and elsewhere is certified as a Class I laser product conforming to the requirements of IEC 825.

Class I laser products are not considered to be hazardous. The laser system and printer are designed so there is never any human access to laser radiation above a Class I level during normal operation, user maintenance or prescribed service condition.

WARNING

Never operate or service the printer with the protective cover removed from Laser/Scanner assembly. The reflected beam, although invisible, can damage your eyes.

When using this product, these basic safety precautions should always be followed to reduce risk of fire, electric shock, and injury to persons:

	CAUTION - CLASS 3B LASER RADIATION WHEN OPEN AVOID EXPOSURE TO THE BEAM.
	DANGER - LASER RADIATION AVOID DIRECT EXPOSURE TO BEAM.
	DANGER - RADIATIONS INVISIBLES DU LASER EN CAS D'OUVERTURE. EVITER TOUTE EXPOSITION DIRECTE AU FAISCEAU.
	VORSICHT - UNSICHTBARE LASERSTRAHLUNG, WENN ABDECKUNG GEÖFFNET. NICHT DEM STRAHL AUSSETZEN.
	ATTENZIONE - RADIAZIONE LASER INVISIBILE IN CASO DI APERTURA, EVITARE L'ESPOSIZIONE AL FASCIO.
	PRECAUCIÓN - RADIACIÓN LASER INVISIBLE CUANDO SE ABRE. EVITAR EXPONERSE AL RAYO.
	PERIGO - RADIAÇÃO LASER INVISÍVEL AO ABRIR. EVITE EXPOSIÇÃO DIRECTA AO FEIXE.
	GEVAAR - ONZICHTBARE LASERSTRALLEN BIJ GEOPENDE KLEP. DEZE KLEP NIET OPENEN.
	ADVARSEL - USYNLIG LASERSTRÅLNING VED ÅBNING. UNDGÅ UDSAETTELSE FOR STRÅLNING.
	ADVARSEL - USYNLIG LASERSTRÅLNING NÅR DEKSEL ÅPNES. UNNGÅ EKSPONERING FOR STRÅLEN.
VARNING - OSYNLIG LASERSTRÅLNING NÅR DENNA DEL ÄR ÖPPEN. STRÅLEN ÄR FARLIG.	
VAROITUS - NÄKYMÄTÖNTÄ LASERSÄTEILYÄ AVATTAESSA. VARO SUORAA ALTISTUMISTA SÄTEELLE.	
注 意 - 严禁揭开此盖, 以免激光泄露灼伤	
주 의 - 이 덮개를 열면 레이저광에 노출될 수 있으므로 주의하십시오.	

OZONE SAFETY



During normal operation, this machine produces ozone. The ozone produced does not present a hazard to the operator. However, it is advisable that the machine be operated in a well ventilated area.
If you need additional information about ozone, request your nearest Samsung dealer.

MERCURY SAFETY



Contains Mercury, Dispose According to Local, State or Federal Laws. (U.S.A only)

POWER SAVER



This printer contains advanced energy conservation technology that reduces power consumption when it is not in active use. When the printer does not receive data for an extended period of time, power consumption is automatically lowered. ENERGY STAR and the ENERGY STAR mark are registered U.S. marks.
For more information on the ENERGY STAR program see <http://www.energystar.gov>

RECYCLING



Recycle or dispose of the packaging material for this product in an environmentally responsible manner.

CORRECT DISPOSAL OF THIS PRODUCT (WASTE ELECTRICAL & ELECTRONIC EQUIPMENT)



(Applicable in the European Union and other European countries with separate collection systems)

This marking shown on the product or its literature, indicates that it should not be disposed with other household wastes at the end of its working life. To prevent possible harm to the environment or human health from uncontrolled waste disposal, separate this from other types of wastes and recycle it responsibly to promote the sustainable reuse of material resources.

Household users should contact either the retailer where they purchased this product, or their local government office, for details of where and how they can take this item for environmentally safe recycling.

Business users should contact their supplier and check the terms and conditions of the purchase contract. This product should not be mixed with other commercial wastes for disposal.

RADIO FREQUENCY EMISSIONS

FCC Information to the User

This device complies with Part 15 of the FCC Rules. Operation is subject to the following two conditions:

- This device may not cause harmful interference, and
- This device must accept any interference received, including interference that may cause undesired operation.

This equipment has been tested and found to comply with the limits for a Class A digital device, pursuant to Part 15 of the FCC Rules. These limits are designed to provide reasonable protection against harmful interference in a residential installation. This equipment generates, uses and can radiate radio frequency energy and, if not installed and used in accordance with the instructions, may cause harmful interference to radio communications. However, there is no guarantee that interference will not occur in a particular installation. If this equipment does cause harmful interference to radio or television reception, which can be determined by turning the equipment off and on, the user is encouraged to try to correct the interference by one or more of the following measures:

- Reorient or relocate the receiving antenna.
- Increase the separation between the equipment and receiver.
- Connect the equipment into an outlet on a circuit different from that to which the receiver is connected.

- Consult the dealer or experienced radio TV technician for help.



Change or modifications not expressly approved by the manufacturer responsible for compliance could void the user's authority to operate the equipment.

Canadian Radio Interference Regulations

This digital apparatus does not exceed the Class A limits for radio noise emissions from digital apparatus as set out in the interference-causing equipment standard entitled "Digital Apparatus", ICES-003 of the Industry and Science Canada.

Cet appareil numérique respecte les limites de bruits radioélectriques applicables aux appareils numériques de Classe A prescrites dans la norme sur le matériel brouilleur: "Appareils Numériques", ICES-003 édictée par l'Industrie et Sciences Canada.

UNITED STATES OF AMERICA

Federal Communications Commission (FCC)

Intentional emitter per FCC Part 15

Low power, Radio LAN type devices (radio frequency (RF) wireless communication devices), operating in the 2.4 GHz/5 GHz Band, may be present (embedded) in your printer system. This section is only applicable if these devices are present. Refer to the system label to verify the presence of wireless devices.

Wireless devices that may be in your system are only qualified for use in the United States of America if an FCC ID number is on the system label.

The FCC has set a general guideline of 20 cm (8 inches) separation between the device and the body, for use of a wireless device near the body (this does not include extremities). This device should be used more than 20 cm (8 inches) from the body when wireless devices are on. The power output of the wireless device (or devices), which may be embedded in your printer, is well below the RF exposure limits as set by the FCC.

This transmitter must not be collocated or operation in conjunction with any other antenna or transmitter.

Operation of this device is subject to the following two conditions:(1) This device may not cause harmful interference, and(2) this device must accept any interference received, including interference that may cause undesired operation of the device.



Wireless devices are not user serviceable. Do not modify them in any way. Modification to a wireless device will void the authorization to use it. Contact manufacturer for service.



FCC Statement for Wireless LAN use:

While installing and operating this transmitter and antenna combination the radio frequency exposure limit of 1mW/cm² may be exceeded at distances close to the antenna installed. Therefore, the user must maintain a minimum distance of 20cm from the antenna at all times. This device cannot be collocated with another transmitter and transmitting antenna.

FAX BRANDING

The Telephone Consumer Protection Act of 1991 makes it unlawful for any person to use a computer or other electronic device to send any message via a telephone facsimile machine unless such message clearly contains in a margin at the top or bottom of each transmitted page or on the first page of the transmission the following information:

- (1) the date and time of transmission
- (2) identification of either business, business entity or individual sending the message; and
- (3) telephone number of either the sending machine, business, business entity or individual.

The Telephone Company may make changes in its communications facilities, equipment operations or procedures where such action is reasonably required in the operation of its business and is not inconsistent with the rules and regulations in FCC Part 68. If such changes can be reasonably expected to render any customer terminal equipment incompatible with telephone company communications facilities, or require modification or alteration of such terminal equipment, or otherwise materially affect its use or performance, the customer shall be given adequate notice in writing, to allow the customer an opportunity to maintain uninterrupted service

RINGER EQUIVALENCE NUMBER

The Ringer Equivalence Number and FCC Registration Number for this machine may be found on the label located on the bottom or rear of the machine. In some instances you may need to provide these numbers to the telephone company.

The Ringer Equivalence Number (REN) is a measure of the electrical load placed on the telephone line, and is useful for determining whether you have “overloaded” the line. Installing several types of equipment on the same telephone line may result in problems making and receiving telephone calls, especially ringing when your line is called. The sum of all Ringer Equivalence Numbers of the equipment on your telephone line should be less than five in order to assure proper service from the telephone company. In some cases, a sum of five may not be usable on your line. If any of your telephone equipment is not operating properly, you should immediately remove it from your telephone line, as it may cause harm to the telephone network.



FCC Regulations state that changes or modifications to this equipment not expressly approved by the manufacturer could void the user's authority to operate this equipment. In the event that terminal equipment causes harm to the telephone network, the telephone company should notify the customer that service may be stopped. However, where prior notice is impractical, the company may temporarily cease service, providing that they:

- a) promptly notify the customer.
- b) give the customer an opportunity to correct the equipment problem.
- c) inform the customer of the right to bring a complaint to the Federal Communication Commission pursuant to procedures set out in FCC Rules and Regulations Subpart E of Part 68.

You should also know that:

- Your machine is not designed to be connected to a digital PBX system.
- If you intend to use a computer modem or fax modem on the same phone line as your machine, you may experience transmission and reception problems with all the equipment. It is recommended that no other equipment, except for a regular telephone, share the line with your machine.
- If your area experiences a high incidence of lightning or power surges, we recommend that you install surge protectors for both the power and the telephone lines. Surge protectors can be purchased from your dealer or telephone and electronic specialty stores.
- When programming emergency numbers and/or making test calls to emergency numbers, use a non-emergency number to advise the emergency service dispatcher of your intentions. The dispatcher will give you further instructions on how to actually test the emergency number.
- This machine may not be used on coin service or party lines.
- This machine provides magnetic coupling to hearing aids.

You may safely connect this equipment to the telephone network by means of a standard modular jack, USOC RJ-11C.

REPLACING THE FITTED PLUG (FOR UK ONLY)

Important

The mains lead for this machine is fitted with a standard (BS 1363) 13 amp plug and has a 13 amp fuse. When you change or examine the fuse, you must re-fit the correct 13 amp fuse. You then need to replace the fuse cover. If you have lost the fuse cover, do not use the plug until you have another fuse cover.

Contact the people from you purchased the machine.

The 13 amp plug is the most widely used type in the UK and should be suitable. However, some buildings (mainly old ones) do not have normal 13 amp plug sockets. You need to buy a suitable plug adaptor. Do not remove the moulded plug.



If you cut off the moulded plug, get rid of it straight away.

You cannot rewire the plug and you may receive an electric shock if you plug it into a socket.



Important warning:

You must earth this machine.

The wires in the mains lead have the following color code:

- Green and Yellow: Earth
- Blue: Neutral
- Brown: Live

If the wires in the mains lead do not match the colors marked in your plug, do the following:

You must connect the green and yellow wire to the pin marked by the letter “E” or by the safety ‘Earth symbol’ or colored green and yellow or green.

You must connect the blue wire to the pin which is marked with the letter “N” or colored black.

You must connect the brown wire to the pin which is marked with the letter “L” or colored red.

You must have a 13 amp fuse in the plug, adaptor, or at the distribution board.

DECLARATION OF CONFORMITY (EUROPEAN COUNTRIES)



Approvals and Certifications

The CE marking applied to this product symbolizes Samsung Electronics Co., Ltd. Declaration of Conformity with the following applicable 93/68/EEC Directives of the European Union as of the dates indicated:

January 1, 1995: Council Directive 73/23/EEC Approximation of the laws of the member states related to low voltage equipment.

January 1, 1996: Council Directive 89/336/EEC (92/31/EEC), approximation of the laws of the Member States related to electromagnetic compatibility.

March 9, 1999: Council Directive 1999/5/EC on radio equipment and telecommunications terminal equipment and the mutual recognition of their conformity. A full declaration, defining the relevant Directives and referenced standards can be obtained from your Samsung Electronics Co., Ltd. representative.

EC Certification

Certification to 1999/5/EC Radio Equipment & Telecommunications Terminal Equipment Directive (FAX)

This Samsung product has been self-certified by Samsung for pan-European single terminal connection to the analogue public switched telephone network (PSTN) in accordance with Directive 1999/5/EC. The product has been designed to work with the national PSTNs and compatible PBXs of the European countries:

In the event of problems, you should contact the Euro QA Lab of Samsung Electronics Co., Ltd. in the first instance.

The product has been tested against TBR21. To assist in the use and application of terminal equipment which complies with this standard, the European Telecommunication Standards Institute (ETSI) has issued an advisory document (EG 201 121) which contains notes and additional requirements to ensure network compatibility of TBR21 terminals. The product has been designed against, and is fully compliant with, all of the relevant advisory notes contained in this document.

European Radio Approval Information (for products fitted with EU-approved radio devices)

Low power, Radio LAN type devices (radio frequency (RF) wireless communication devices), operating in the 2.4 GHz/5 GHz band, may be present (embedded) in your printer system which is intended for home or office use. This section is only applicable if these devices are present. Refer to the system label to verify the presence of wireless devices.

Wireless devices that may be in your system are only qualified for use in the European Union or associated areas if a CE mark with **CE** a Notified Body Registration Number and the Alert Symbol is on the system label.

The power output of the wireless device or devices that may be embedded in you printer is well below the RF exposure limits as set by the European Commission through the R&TTE directive.

European States qualified under wireless approvals:

EU Austria, Belgium, Cyprus, Czech Republic, Denmark, Estonia, Finland, France (with frequency restrictions), Germany, Greece, Hungary, Ireland, Italy, Latvia, Lithuania, Luxembourg, Malta, The Netherlands, Poland, Portugal, Slovakia, Slovenia, Spain, Sweden and the U.K.

EEA/EFTA countries Iceland, Liechtenstein, Norway and Switzerland

European States with restrictions on use:

EU In France, the frequency range is restricted to 2446.5-2483.5 MHz for devices above 10 mW transmitting power such as wireless

EEA/EFTA countries No limitations at this time.

REGULATORY COMPLIANCE STATEMENTS

Wireless Guidance

Low power, Radio LAN type devices (radio frequency (RF) wireless communication devices), operating in the 2.4 GHz/5 GHz Band, may be present (embedded) in your printer system. The following section is a general overview of considerations while operating a wireless device.

Additional limitations, cautions, and concerns for specific countries are listed in the specific country sections (or country group sections). The wireless devices in your system are only qualified for use in the countries identified by the Radio Approval Marks on the system rating label. If the country you will be using the wireless device in, is not listed, contact your local Radio Approval agency for requirements. Wireless devices are closely regulated and use may not be allowed.

The power output of the wireless device or devices that may be embedded in your printer is well below the RF exposure limits as known at this time. Because the wireless devices (which may be embedded into your printer) emit less energy than is allowed in radio frequency safety standards and recommendations, manufacturer believes these devices are safe for use. Regardless of the power levels, care should be taken to minimize human contact during normal operation.

As a general guideline, a separation of 20 cm (8 inches) between the wireless device and the body, for use of a wireless device near the body (this does not include extremities) is typical. This device should be used more than 20 cm (8 inches) from the body when wireless devices are on and transmitting.

This transmitter must not be collocated or operation in conjunction with any other antenna or transmitter.

Some circumstances require restrictions on wireless devices. Examples of common restrictions are listed below:



Radio frequency wireless communication can interfere with equipment on commercial aircraft. Current aviation regulations require wireless devices to be turned off while traveling in an airplane. IEEE 802.11 (also known as wireless Ethernet) and Bluetooth communication devices are examples of devices that provide wireless communication.



In environments where the risk of interference to other devices or services is harmful or perceived as harmful, the option to use a wireless device may be restricted or eliminated. Airports, Hospitals, and Oxygen or flammable gas laden atmospheres are limited examples where use of wireless devices may be restricted or eliminated. When in environments where you are uncertain of the sanction to use wireless devices, ask the applicable authority for authorization prior to use or turning on the wireless device.



Every country has different restrictions on the use of wireless devices. Since your system is equipped with a wireless device, when traveling between countries with your system, check with the local Radio Approval authorities prior to any move or trip for any restrictions on the use of a wireless device in the destination country.



If your system came equipped with an internal embedded wireless device, do not operate the wireless device unless all covers and shields are in place and the system is fully assembled.



Wireless devices are not user serviceable. Do not modify them in any way. Modification to a wireless device will void the authorization to use it. Contact manufacturer for service.



Only use drivers approved for the country in which the device will be used. See the manufacturer System Restoration Kit, or contact manufacturer Technical Support for additional information.

OPENSSL LICENSE

Copyright (c) 1998-2001 The OpenSSL Project. All rights reserved.

Redistribution and use in source and binary forms, with or without modification, are permitted provided that the following conditions are met:

1. Redistributions of source code must retain the above copyright notice, this list of conditions and the following disclaimer.
2. Redistributions in binary form must reproduce the above copyright notice, this list of conditions and the following disclaimer in the documentation and/or other materials provided with the distribution.
3. All advertising materials mentioning features or use of this software must display the following acknowledgment: "This product includes software developed by the OpenSSL Project for use in the OpenSSL Toolkit. (<http://www.openssl.org/>)"
4. The names "OpenSSL Toolkit" and "OpenSSL Project" must not be used to endorse or promote products derived from this software without
5. prior written permission. For written permission, please contact openssl-core@openssl.org.
6. Products derived from this software may not be called "OpenSSL" nor may "OpenSSL" appear in their names without prior written permission of the OpenSSL Project.
7. Redistributions of any form whatsoever must retain the following acknowledgment: "This product includes software developed by the OpenSSL Project for use in the OpenSSL Toolkit (<http://www.openssl.org/>)"

THIS SOFTWARE IS PROVIDED BY THE OpenSSL PROJECT ``AS IS" AND ANY EXPRESSED OR IMPLIED WARRANTIES, INCLUDING, BUT NOT LIMITED TO, THE IMPLIED WARRANTIES OF MERCHANTABILITY AND FITNESS FOR A PARTICULAR PURPOSE ARE DISCLAIMED. IN NO EVENT SHALL THE OpenSSL PROJECT OR ITS CONTRIBUTORS BE LIABLE FOR ANY DIRECT, INDIRECT, INCIDENTAL, SPECIAL, EXEMPLARY, OR CONSEQUENTIAL DAMAGES (INCLUDING, BUT NOT LIMITED TO, PROCUREMENT OF SUBSTITUTE GOODS OR SERVICES; LOSS OF USE, DATA, OR PROFITS; OR BUSINESS INTERRUPTION) HOWEVER CAUSED AND ON ANY THEORY OF LIABILITY, WHETHER IN CONTRACT, STRICT LIABILITY, OR TORT (INCLUDING NEGLIGENCE OR OTHERWISE) ARISING IN ANY WAY OUT OF THE USE OF THIS SOFTWARE, EVEN IF ADVISED OF THE POSSIBILITY OF SUCH DAMAGE.

This product includes cryptographic software written by Eric Young(eay@cryptsoft.com). This product includes software written by Tim Hudson (tjh@cryptsoft.com).

ORIGINAL SLEAY LICENSE

Copyright (C) 1995-1998 Eric Young (eay@cryptsoft.com) All rights reserved.

This package is an SSL implementation written by Eric Young (eay@cryptsoft.com). The implementation was written so as to conform with Netscapes SSL.

This library is free for commercial and non-commercial use as long as the following conditions are aheared to. The following conditions apply to all code found in this distribution, be it the RC4, RSA, lhash, DES, etc., code; not just the SSL code. The SSL documentation included with this distribution is covered by the same copyright terms except that the holder is Tim Hudson (tjh@cryptsoft.com). Copyright remains Eric Young's, and as such any Copyright notices in the code are not to be removed. If this package is used in a product, Eric Young should be given attribution as the author of the parts of the library used. This can be in the form of a textual message at program startup or in documentation (online or textual) provided with the package.

Redistribution and use in source and binary forms, with or without modification, are permitted provided that the following conditions are met:

1. Redistributions of source code must retain the copyright notice, this list of conditions and the following disclaimer.
2. Redistributions in binary form must reproduce the above copyright notice, this list of conditions and the following disclaimer in the documentation and/or other materials provided with the distribution.
3. All advertising materials mentioning features or use of this software must display the following acknowledgement: "This product includes cryptographic software written by Eric Young (eay@cryptsoft.com)" The word 'cryptographic' can be left out if the rouines from the library being used are not cryptographic related:-).
4. If you include any Windows specific code (or a derivative thereof) from the apps directory (application code) you must include an acknowledgement: "This product includes software written by Tim Hudson (tjh@cryptsoft.com)"

THIS SOFTWARE IS PROVIDED BY ERIC YOUNG ``AS IS" AND ANY EXPRESS OR IMPLIED WARRANTIES, INCLUDING, BUT NOT LIMITED TO, THE IMPLIED WARRANTIES OF MERCHANTABILITY AND FITNESS FOR A PARTICULAR PURPOSE ARE DISCLAIMED. IN NO EVENT SHALL THE AUTHOR OR CONTRIBUTORS BE LIABLE FOR ANY DIRECT, INDIRECT, INCIDENTAL, SPECIAL, EXEMPLARY, OR CONSEQUENTIAL DAMAGES (INCLUDING, BUT NOT LIMITED TO, PROCUREMENT OF SUBSTITUTE GOODS OR SERVICES; LOSS OF USE, DATA, OR PROFITS; OR BUSINESS INTERRUPTION) HOWEVER CAUSED AND ON ANY THEORY OF LIABILITY, WHETHER IN CONTRACT, STRICT LIABILITY, OR TORT (INCLUDING NEGLIGENCE OR OTHERWISE) ARISING IN ANY WAY OUT OF THE USE OF THIS SOFTWARE, EVEN IF ADVISED OF THE POSSIBILITY OF SUCH DAMAGE.

The licence and distribution terms for any publically available version or derivative of this code cannot be changed. i.e. this code cannot simply be copied and put under another distribution licence [including the GNU Public Licence.]

	2	Features of your new laser product
	5	Safety information
INTRODUCTION	19	Printer overview
	19	Front view
	19	Rear view
	20	Control panel overview
	20	MFJ-C2500
	21	
	22	Understanding the Status LED
	22	Acknowledging the status of the toner cartridge
	23	Menu overview
	24	Supplied software
	24	Printer driver features
	24	Printer driver
	24	PostScript driver
GETTING STARTED	25	Setting up the hardware
	25	Printing a demo page
	25	Setting up the network
	25	Supported operating environments
	26	Configuring network protocol via the machine
	26	Using the SetIP program
	26	System requirements
	26	Windows
	26	Macintosh
	27	Linux
	27	Installing the software
	28	Machine's basic settings
	28	Altitude adjustment
	28	Changing the display language
	29	Setting the date and time
	29	Changing the clock mode
	29	Changing the default mode
	29	Setting sounds
	29	Entering characters using the number keypad
	30	Using the save modes
	30	Setting print job timeout
	30	Auto continue
	30	Net accounting
	31	Changing the font setting
LOADING ORIGINALS AND PRINT MEDIA	32	Loading originals
	32	On the scanner glass
	32	In the DADF (or ADF)
	33	Selecting print media
	34	Specifications on print media
	35	Media sizes supported in each mode
	35	Guidelines for special print media
	36	Changing the size of the paper in the paper tray
	36	Loading paper
	36	Loading paper in the tray 1 or optional tray
	37	Loading paper in the multi-purpose tray
	38	Adjusting the output support
	38	For Letter-sized paper

- 38 For A4- or Legal-sized paper
- 38 Setting the paper size and type**

COPYING

39

- 39 Selecting the paper tray**
- 39 Copying**
- 39 Changing the settings for each copy**
 - 39 Darkness
 - 39 Original Type
 - 39 Reduced or enlarged copy
- 40 Changing the scan size settings**
- 40 Changing the default copy settings**
- 40 ID card copying**
- 40 Using special copy features**
 - 40 Collation
 - 40 2-up or 4-up copying
 - 41 Poster copying
 - 41 Clone copying
 - 41 Adjusting background images
 - 41 Book copying
 - 41 Margin shift
 - 42 Edge erase
 - 42 Gray enhance copying
- 42 Printing on both sides of paper**
- 42 Setting copy timeout**

SCANNING

43

- 43 Scanning basics**
- 43 Scanning from the control panel**
 - 43 Setting scan information in Samsung Scan Manager.
 - 43 Scanning to application programs
- 44 Scanning by a network connection**
 - 44 Preparing for network scanning
 - 45 Scanning to Email
 - 46 Scanning to an FTP server
 - 46 Scanning to an SMB server
- 46 Changing the settings for each scan job**
- 46 Changing the default scan settings**
- 46 printing scan confirmation report automatically**
- 47 Setting up Address Book**
 - 47 Registering speed email numbers
 - 47 Configuring group email numbers
 - 47 Retrieving global email addresses from the LDAP server
 - 47 Using Address Book entries
 - 47 Searching Address Book for an entry
 - 48 Printing Address Book
- 48 Scan on both sides of paper**

BASIC PRINTING

49

- 49 Printing a document**
- 49 Canceling a print job**

FAXING

50

- 50 Sending a fax**
 - 50 Setting the fax header
 - 50 Adjusting the document settings
 - 51 Sending a fax automatically

51	Sending a fax manually
51	Confirming a transmission
51	Automatic redialing
51	Redialing the last number
51	Sending faxes on both sides of paper
51	Receiving a fax
51	Selecting the paper tray
51	Changing receiving modes
52	Receiving automatically in Fax mode
52	Receiving manually in Tel mode
52	Receiving manually using an extension telephone
52	Receiving automatically in Ans/Fax mode
52	Receiving faxes using DRPD mode
52	Receiving in secure receiving mode
52	Activating secure receiving mode
53	Receiving faxes in memory
53	Other ways to fax
53	Sending a fax to multiple destinations
53	Sending a delayed fax
54	Sending a priority fax
54	Forwarding faxes
55	Fax setup
55	Changing the fax setup options
56	Changing the default document settings
56	Printing sent fax report automatically
56	Setting up Address Book

USING USB FLASH MEMORY

58

58	About USB memory
58	Plugging in a USB memory device
58	Scanning to a USB memory device
58	Scanning
59	Customizing Scan to USB
59	Printing from a USB memory device
59	To print a document from a USB memory device:
59	Backing up data
59	Backing up data
59	Restoring data
60	Managing USB memory
60	Deleting an image file
60	Formatting a USB memory device
60	Viewing the USB memory status

MAINTENANCE

61

61	Printing reports
61	Printing a report
61	Adjusting the color contrast
62	Clearing memory
62	Cleaning your machine
62	Cleaning the outside
62	Cleaning the inside
64	Cleaning the scan unit
64	Maintaining the cartridge
64	Toner cartridge storage
64	Expected cartridge life
64	Redistributing toner
65	Replacing the toner cartridge
66	Clearing the Toner Empty message
67	Replacing the paper transfer belt

	68 Maintenance parts
	68 Checking replaceables
	68 Replacing the DADF (or ADF) rubber pad
	69 Managing your machine from the website
	69 To access SyncThru™ Web Service:
	69 Checking the machine's serial number
70	70 Tips for avoiding paper jams
	70 Clearing document jams
	70 Input Misfeed
	71 Exit misfeed
	71 Roller misfeed
	72 Clearing paper jams
	72 In the paper feed area
	73 In the multi-purpose tray
	74 In the fuser unit area
	75 In the paper exit area
	76 In the optional tray
	77 Understanding display messages
	80 Solving other problems
	80 Paper feeding
	81 Printing problems
	82 Printing quality problems
	84 Copying problems
	85 Scanning problems
	85 Samsung Scan Manager problems
	85 Fax problems
	86 Common PostScript problems
	86 Common Windows problems
	87 Common Linux problems
	89 Common Macintosh problems
90	90 Supplies
	90 Accessories
	91
92	92 Precautions to take when installing accessories
	92 Upgrading a memory module
	92 Installing a memory module
	93 Activating the added memory in the PS printer properties
	93 Using a wireless network interface card
	93 Installing a wireless network interface card
	94 Configuring basic network settings
	94 Selecting the authentication type
	94 Setting Encryption
	95 Restoring default values for wireless networking
	95 Using the hard disk
	95 Installing the hard disk
	96 Setting the hard disk in the printer properties
	96 Printing with the optional hard disk
	97 File Policy
	97 Deleting residual image data

contents

SPECIFICATIONS	98	General specifications
		99 Printer specifications
		99 Scanner specifications
		99 Copier specifications
		100 Facsimile specifications

GLOSSARY

101

INDEX

105

introduction

These are the main components of your machine:

This chapter includes:

- Printer overview
- Control panel overview
- Understanding the Status LED
- Acknowledging the status of the toner cartridge
- Menu overview
- Supplied software
- Printer driver features

PRINTER OVERVIEW

Front view

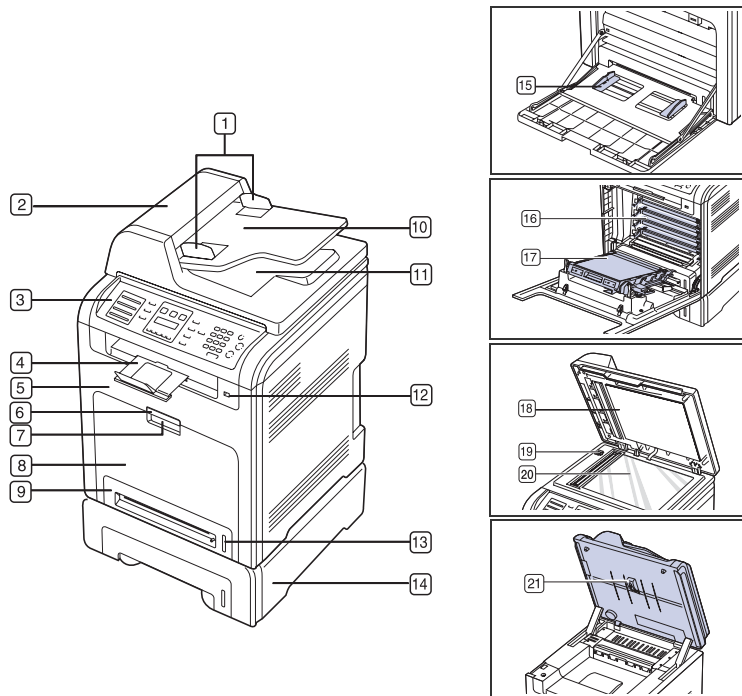

1	Document width guides	12	USB memory port
2	DADF	13	Paper level indicator
3	Control panel	14	Optional tray 2
4	Output support	15	Multi-purpose tray paper width guides
5	Front cover	16	Toner cartridge
6	Front cover handle	17	Paper transfer belt
7	Multi-purpose tray handle	18	Scanner lid
8	Multi-purpose tray	19	Scanner lock switch

9	Tray 1	20	Scanner glass
10	Document input tray	21	Scan unit
11	Document output tray		

Rear view

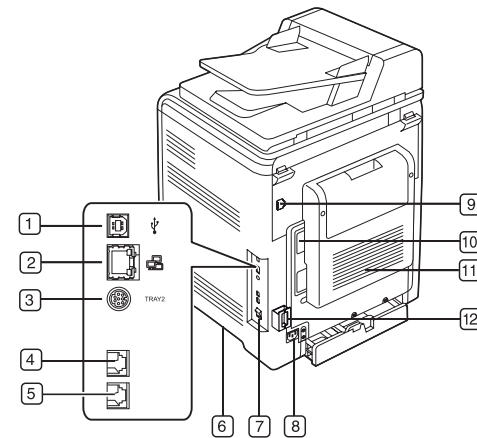

1	USB port	7	Power switch
2	Network port	8	Power receptacle
3	15-pin optional tray connection	9	External device interface (EDI)
4	Telephone line socket	10	Control board cover
5	Extension telephone socket (EXT)	11	Rear cover
6	Handle	12	Cable organizer

CONTROL PANEL OVERVIEW

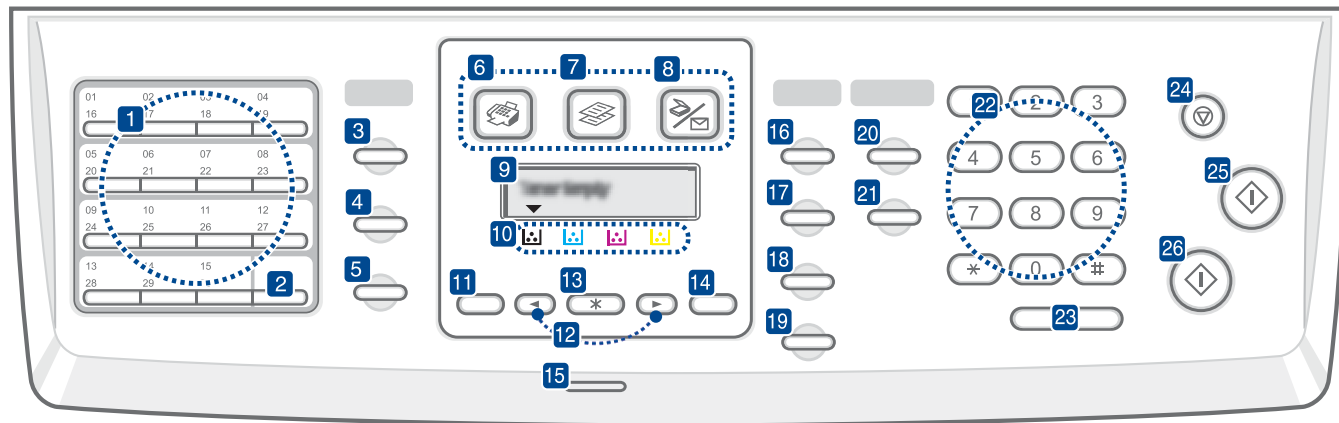

1 Speed buttons	Allows you to store frequently-dialed fax numbers and enter them with the touch of a few buttons.
2 Shift	Allows you to shift the speed buttons to access numbers 16 through 30.
3 Address Book	Allows you to store frequently used fax numbers in memory or search for stored fax numbers or email addresses.
4 Resolution	Adjusts the document resolution for the current fax job.
5 Redial/Pause	In ready mode, redials the last number, or in Edit mode, inserts a pause into a fax number.
6 Fax	Activates Fax mode.
7 Copy	Activates Copy mode.
8 Scan/Email	Activates Scan mode.
9 Display	Shows the current status and prompts during an operation.
10 Toner colors	The toner colors shown below the LCD display co-works with the display messages. See Status LED with the toner cartridge messages on page 22.
11 Menu	Enters Menu mode and scrolls through the available menus.
12 Left/right arrow	Scroll through the options available in the selected menu, and increase or decrease values.
13 OK	Confirms the selection on the screen.
14 Back	Sends you back to the upper menu level.
15 Status	Shows the status of your machine. See page 22.
16 Darkness	Adjusts the document brightness for the current copy job. See "Darkness" on page 39
17 Original Type	Selects the document type for the current copy job. See "Original Type" on page 39
18 ID Copy	You can copy both sides of the ID Card like a driver's license to a single side of paper. See page 40.
19 Reduce/Enlarge	Makes a copy smaller or larger than the original.
20 Duplex	Allows you to print documents on both sides of the paper.
21 USB Print	Allows you to directly print files stored on a USB Memory device when it is inserted into the USB memory port on the front of your machine. See page 58.
22 Number keypad	Dials a number or enters alphanumeric characters. See page 30.
23 On Hook Dial	Engages the telephone line.
24 Stop/Clear	Stops an operation at any time. In ready mode, clears/cancels the copy options, such as the darkness, the document type setting, the copy size, and the number of copies.
25 Color Start	Starts a job in Color mode.
26 Black Start	Starts a job in Black and White mode.



- All illustrations on this user's guide may differ from your machine depending on its options or models.
- The surface of the output tray may become hot if you print a large number of pages at once. Make sure that you do not touch the surface, and do not allow children near it.

UNDERSTANDING THE STATUS LED

The color of the **Status** LED indicates the machine's current status.

STATUS		DESCRIPTION
Off		<ul style="list-style-type: none">The machine is powered off-line.The machine is in power save mode. When data is received, or any button is pressed, it switches to on-line automatically.
Green	Blinking	<ul style="list-style-type: none">When the green LED slowly blinks, the machine is receiving data from the computer.When the green LED slowly rapidly, the machine is printing data.
	On	<ul style="list-style-type: none">The machine is powered on and can be used.
Red	Blinking	<ul style="list-style-type: none">A minor error has occurred and the machine is waiting for the error to be cleared. Check the display message, and solve the problem referring to "Understanding display messages" on page 77.The toner cartridge is low. Order a new toner cartridge, see "Ordering supplies and accessories" on page 90. You can temporarily improve print quality by redistributing the toner. See "Replacing the toner cartridge" on page 65
	On	<ul style="list-style-type: none">A problem has occurred such as a paper jam, cover is open or no paper in the tray, so that the machine cannot continue the job. Check the message on the display, and refer to "Understanding display messages" on page 77 to solve the problem.The toner cartridge is empty, or needs to be changed. See "Understanding display messages" on page 77

 Always check the message on the display to solve the problem. The instruction in the Troubleshooting section will guide you to operate the machine properly. See "Understanding display messages" on page 77 for more information.

ACKNOWLEDGING THE STATUS OF THE TONER CARTRIDGE

The status of toner cartridges is indicated by the **Status** LED and the LCD display. If the toner cartridge is low or needs to be replaced, the **Status** LED turns red and the display shows the message. However the arrow mark shows which color toner is of concern or may be installed with a new cartridge.

Example:



The above example shows the black cartridges status indicated by arrows. Check the message to find out what the problem is and how to solve it. See page 77 to browse the detailed information on error messages.

SUPPLIED SOFTWARE

You must install the printer and scanner software using the supplied CD after you have set up your machine and connected it to your computer. CD provides you with the following software.

CD	CONTENTS	
Printer software CD	Windows	<ul style="list-style-type: none"> • Printer driver: Use this driver to take full advantage of your printer's features. • Postscript Printer Description (PPD) file: Use the PostScript driver to print documents with complex fonts and graphics in the PS language. • Scanner driver: TWAIN and Windows Image Acquisition (WIA) drivers are available for scanning documents on your machine. • Smart Panel: This program allows you to monitor the machine's status and alerts you when an error occurs during printing. • SmarThru Office^a: This is the accompanying Windows-based software for your multifunctional machine. • Direct Printing Utility: This program allows you to print PDF files directly. • SetIP: Use this program to set your machine's TCP/IP addresses.
	Linux	<ul style="list-style-type: none"> • Postscript Printer Description (PPD) file: Use this file to run your machine from a Linux computer and print documents. • SANE: Use this driver to scan documents. • Smart Panel: This program allows you to monitor the machine's status and alerts you when an error occurs during printing.
	Macintosh	<ul style="list-style-type: none"> • Printer driver: Use this driver to take full advantage of your printer's features. • Postscript Printer Description (PPD) file: Use this file to run your machine from a Macintosh computer and print documents. • Scanner driver: TWAIN driver is available for scanning documents on your machine. • Smart Panel: This program allows you to monitor the machine's status and alerts you when an error occurs during printing.

a. Allows you to edit a scanned image in many ways using a powerful image editor and to send the image by email. You can also open another image editor program, like Adobe Photoshop, from SmarThru. For details, refer to the onscreen help supplied on the SmarThru program.

PRINTER DRIVER FEATURES

Your printer drivers support the following standard features:

- Paper orientation, size, source and media type selection
- Number of copies

In addition, you can use various special printing features. The following table shows a general overview of features supported by your printer drivers:

Printer driver

FEATURE	WINDOWS	LINUX	MACINTOSH
Color mode	O	O	O
Machine quality option	O	O	O
Poster printing	O	X	X
Multiple pages per sheet (N-up)	O	O (2, 4)	O
Fit to page printing	O	X	O ^a
Scale printing	O	X	O
Different source for first page	O	X	O
Watermark	O	X	X
Overlay	O	X	X
Duplex	O	X	O

a. This feature is not supported MAC OS X 10.3.

PostScript driver

FEATURE	WINDOWS	LINUX	MACINTOSH
Color mode	O	O	O
Machine quality option	O	O	O
Poster printing	X	X	X
Multiple pages per sheet (N-up)	O	O (2, 4)	O
Fit to page printing	O	X	O ^a
Scale printing	O	X	O
Different source for first page	X	X	O
Watermark	X	X	X
Overlay	X	X	X
Duplex	O	X	O

a. This feature is not supported MAC OS X 10.3.

getting started

This chapter gives you step-by-step instructions for setting up the machine.

This chapter includes:

- Setting up the hardware
- Printing a demo page
- Setting up the network

SETTING UP THE HARDWARE

This section shows the steps to set up the hardware which is explained in the *Quick Install Guide*. Make sure you read *Quick Install Guide* and complete following steps.

1. Select a stable location.

Select a level, stable place with adequate space for air circulation. Allow extra space to open covers and trays.

The area should be well-ventilated and away from direct sunlight or sources of heat, cold, and humidity. Do not set the machine close to the edge of your desk or table.

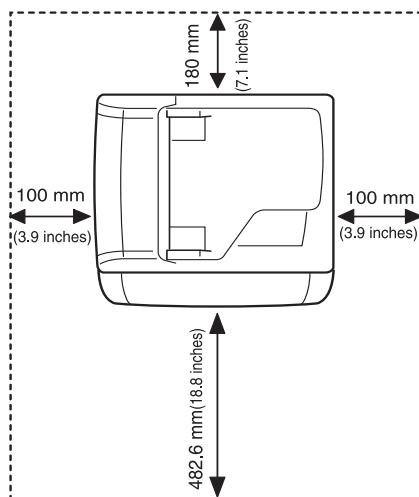

Printing is suitable for altitudes under 1,000 m (3,281 ft). Refer to the altitude setting to optimize your printing. See "Altitude adjustment" on page 28 for more information.

Place the machine on a flat, stable surface so that there is no incline greater than 2 mm (0.08 inch). Otherwise, printing quality may be affected.

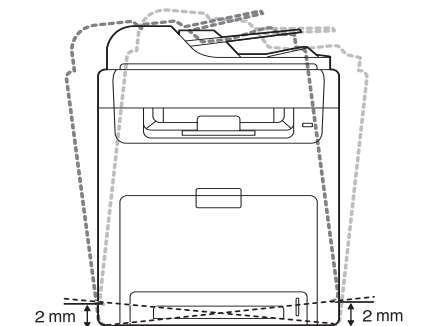

- System requirements
- Installing the software
- Machine's basic settings

2. Unpack the machine and check all the enclosed items.
3. Remove the tape holding the machine tightly.
4. Install the toner cartridge.
5. Load paper. (See "Loading paper" on page 36.)
6. Make sure that all the cables are connected to the machine.
7. Turn the machine on.

 When you move the machine, do not tilt or turn it upside down. Otherwise, the inside of the machine may be contaminated by toner, which can cause damage to the machine or bad print quality.

PRINTING A DEMO PAGE

Print a demo page to make sure that the machine is operating correctly.

To print a demo page:

In ready mode, press and hold the **OK** button for about 2 seconds.

SETTING UP THE NETWORK

You need to set up the network protocols on the machine to use it as your network printer. You can set up the basic network settings through the machine's control panel.

Supported operating environments

The following table shows the network environments supported by the machine:

ITEM	REQUIREMENTS
Network interface	<ul style="list-style-type: none">• Ethernet 10/100 Base-TX• IEEE 802.11 b/g Wireless LAN (optional)
Network operating system	<ul style="list-style-type: none">• Windows 2000/XP/2003/Vista• Various Linux OS• Mac OS X 10.3 ~ 10.5
Network protocols	<ul style="list-style-type: none">• TCP/IP on Windows• IPP• SNMP• DHCP• BOOTP

 If you want to set up DHCP network protocol, go to <http://developer.apple.com/networking/bonjour/download/>, select the Bonjour program that is appropriate for your computer operating system and install the program. This program will allow you to set network parameters automatically. Follow the instructions in the installation window. This program does not support Linux.

Configuring network protocol via the machine

You can set up TCP/IP network parameters, follow the steps listed below.

1. Make sure your machine is connected to the network with an RJ-45 Ethernet cable.
2. Make sure you have turned on the machine.
3. Press **Menu** on the control panel, until you see **Network** on the bottom line of the display.
4. Press **OK** to access the menu.
5. Press the left/right arrow until **TCP/IP** displays.
6. Press **OK**.
7. Press the left/right arrow until **Static** displays.
8. Press **OK**.
9. Press the left/right arrow until **IP Address** displays.
10. Press **OK**.
Enter a byte between 0 and 255 using the number keypad and press the left/right arrow to move between bytes.
Repeat this to complete the address from the 1st byte to the 4th byte.
11. When you have finished, press **OK**.
Repeat steps 9 and 10 to configure the other TCP/IP parameters: subnet mask and gateway address.

 Contact the network administrator if you are not sure how to configure.

-  You can also set up the network settings through the network administration programs.
- **SyncThru™ Web Admin Service:** Web-based printer management solution for network administrators. **SyncThru™ Web Admin Service** provides you with an efficient way of managing network devices and lets you remotely monitor and troubleshoot network machines from any site with corporate internet access. Download this program from <http://solution.samsungprinter.com>.
 - **SyncThru™ Web Service:** Web server embedded on your network print server, which allows you to:
 - Configure the network parameters necessary for the machine to connect to various network environments.
 - Customize machine settings.
 - **SetIP:** Utility program allowing you to select a network interface and manually configure the IP addresses for use with the TCP/IP protocol.





Using the SetIP program

This program is for the network IP setting using the MAC address which is the hardware serial number of the network printer card or interface. Especially, it is for the network administrator to set several network IPs at the same time.

Installing the program

1. Insert the driver CD provided along with your machine. When the driver CD runs automatically, close the window.
2. Start **Windows Explorer** and open the X drive. (X represents your CD-ROM drive.)
3. Double click **Application > SetIP**.
4. Open the folder of the language you plan to use.
5. Double click **Setup.exe** to install this program.
6. Follow the instructions in the window and complete the installation.

Starting the program

1. From the Windows **Start** menu, select **All Programs > Samsung Network Printer Utilities > SetIP**.
2. Select the name of your printer and click .
 -  If you cannot find your printer name, click  to refresh the list.
3. Enter the network card's MAC address, IP address, subnet mask, default gateway, and then click **Apply**.
 -  If you do not know the network card's MAC address, print the machine's network information report. (See "Printing reports" on page 61.)
4. Click **OK** to confirm the settings.
5. Click **Exit** to close the **SetIP** program.

SYSTEM REQUIREMENTS

Before you begin, ensure that your system meets the following requirements:

Windows

Your machine supports the following Windows operating systems.

OPERATING SYSTEM	REQUIREMENT (RECOMMENDED)		
	CPU	RAM	FREE HDD SPACE
Windows 2000	Pentium II 400 MHz (Pentium III 933 MHz)	64 MB (128 MB)	600 MB
Windows XP	Pentium III 933 MHz (Pentium IV 1 GHz)	128 MB (256 MB)	1.5 GB
Windows 2003 Server	Pentium III 933 MHz (Pentium IV 1 GHz)	128 MB (512 MB)	1.25 GB to 2 GB
Windows Vista	Pentium IV 3 GHz	512 MB (1024 MB)	15 GB

-  • Internet Explorer 5.0 or higher is the minimum requirement for all Windows operating systems.
- Users who have an administrator right can install the software.

Macintosh

OPERATING SYSTEM	REQUIREMENT (RECOMMENDED)		
	CPU	RAM	FREE HDD SPACE
Mac OS X 10.3 ~ 10.4	<ul style="list-style-type: none">• Intel Processor• Power PC G4 / G5	<ul style="list-style-type: none">• 128 MB for a Power-PC based Mac (512 MB).• 512 MB for an Intel-based Mac (1 GB)	1 GB
Mac OS X 10.5	<ul style="list-style-type: none">• Intel Processor• 867 MHz or faster Power PC G4 /G5	512 MB (1 GB)	1 GB

Linux

ITEM	REQUIREMENTS
Operating system	RedHat 8.0, 9.0 (32bit) RedHat Enterprise Linux WS 4, 5 (32/64bit) Fedora Core 1~7 (32/64bit) Mandrake 9.2 (32bit), 10.0, 10.1 (32/64bit) Mandriva 2005, 2006, 2007 (32/64bit) SuSE Linux 8.2, 9.0, 9.1 (32bit) SuSE Linux 9.2, 9.3, 10.0, 10.1, 10.2 (32/64bit) SuSE Linux Enterprise Desktop 9, 10 (32/64bit) Ubuntu 6.06, 6.10, 7.04 (32/64bit) Debian 3.1, 4.0 (32/64bit)
CPU	Pentium IV 2.4GHz (IntelCore2)
RAM	512 MB (1024 MB)
Free HDD space	1 GB (2GB)

- It is necessary to claim swap partition of 300 MB or larger for working with large scanned images.
- The Linux scanner driver supports the optical resolution at maximum.

INSTALLING THE SOFTWARE

You have to install the machine software for printing. The software includes drivers, applications, and other user friendly programs.

- The following procedure is for when the machine is being used as a network machine. If you want to connect a machine with a USB cable, refer to *Software section*.
- The following procedure is based on the Windows XP operating system. The procedure and popup window which appear during the installation may differ depending on the operating system, the printer feature, or the interface in use.

1. Connect the network cable to your machine.
2. Make sure that the network setup for your machine is completed. (See "Setting up the network" on page 25.) All applications should be closed on your computer before beginning installation.
3. Insert the Printer Software CD-ROM into your CD-ROM drive. The CD-ROM should automatically run, and an installation window appears. If the installation window does not appear, click **Start > Run**. Type X:\Setup.exe, replacing "X" with the letter which represents your drive and click **OK**. If you use Windows Vista, click **Start > All Programs > Accessories > Run**, and type X:\Setup.exe. If the **AutoPlay** window appears in Windows Vista, click **Run Setup.exe** in **Install or run program** field, and click **Continue** in the **User Account Control** window.

4. Click **Next**.

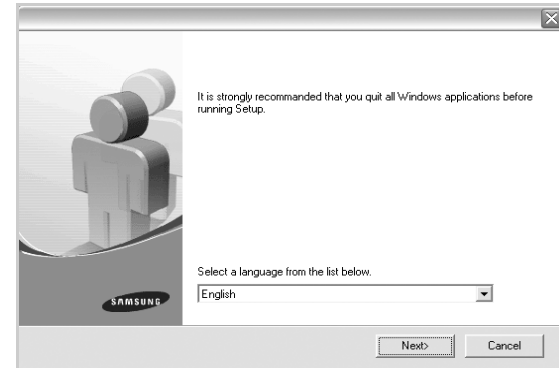

- If necessary, select a language from the drop-down list.
5. Select **Typical installation for a network printer**, and then click **Next**.

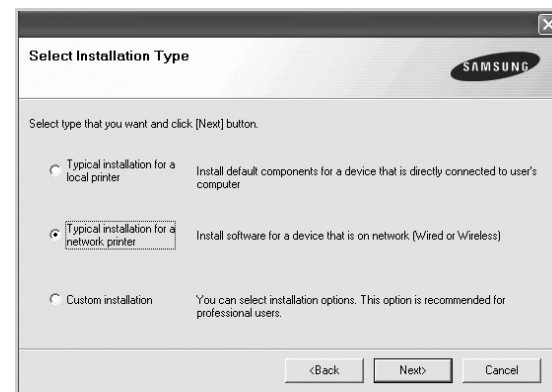

6. The list of machines available on the network appears. Select the printer you want to install from the list and then click **Next**.

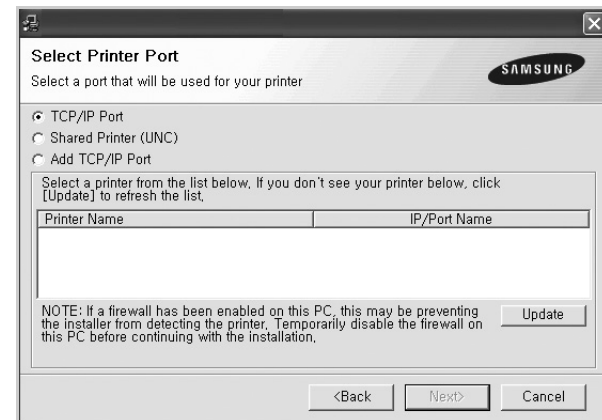

- If you do not see your machine on the list, click **Update** to refresh the list, or select **Add TCP/IP Port** to add your machine to the network. To add the machine to the network, enter the port name and the IP address for the machine. To verify your machine's IP address or the MAC address, print a Network Configuration page. (See "Printing reports" on page 61.)
- To find a shared network printer (UNC Path), select **Shared Printer [UNC]** and enter the shared name manually or find a shared printer

by clicking the **Browse** button.



If you are not sure of the IP address, contact your network administrator or print network information. (See "Printing reports" on page 61.)

7. Select the corresponding checkbox(es) and click **Finish**.

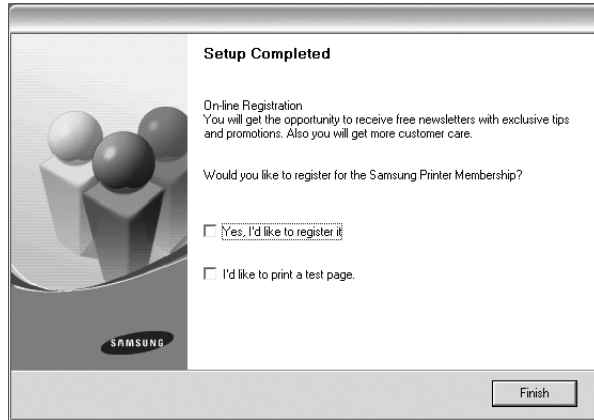

- If your machine does not work properly after the installation, try to reinstall the printer driver. See *Software section*.
- During the printer driver installation process, the driver installer detects the location information for your operating system and sets the default paper size for your machine. If you use a different Windows location, you must change the paper size to match the paper you usually use. Go to printer properties to change the paper size after installation is complete.

MACHINE'S BASIC SETTINGS

After installation is complete, you may want to set the machine's default settings. Refer to the next section if you would like to set or change values.

Altitude adjustment

The print quality is affected by atmospheric pressure, which is determined by the height of the machine above sea level. The following information will guide you on how to set your machine to the best print quality or best quality of print.

Before you set the altitude value, find the altitude where you are using the machine.

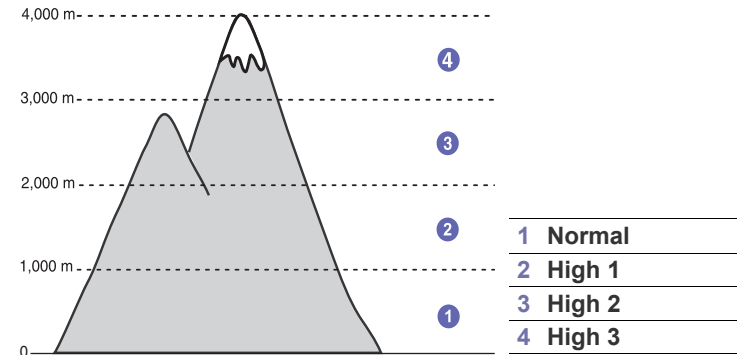

1. Ensure that you have installed the printer driver with the provided Printer Software CD.
2. Double-click the **Smart Panel** icon on the Windows task bar (or Notification Area in Linux). You can also click **Smart Panel** on the status bar in Mac OS X.
3. Click **Printer Setting**.
4. Click **Setting > Altitude Adjustment**. Select the appropriate value from the dropdown list, and then click **Apply**.



If your machine is connected to a network, **SyncThru Web Service** screen appears automatically. Click **Machine Settings > Setup** (or **Machine Setup**) > **Altitude adj.**. Select the appropriate altitude value, and then click **Apply**.

Changing the display language

To change the language that appears on the control panel, follow these steps:

1. Press **Menu** until **System Setup** appears on the bottom line of the display and press **OK**.
2. Press **OK** when **Machine Setup** appears.
3. Press the left/right arrow until **Language** appears and press **OK**.
4. Press the left/right arrow until the language you want appears and press **OK**.
5. Press **Stop/Clear** to return to ready mode.

Setting the date and time

The current date and time are shown on the display when your machine is on and ready to work. All of your faxes will have the date and time printed on them.

1. Press **Menu** until **System Setup** appears on the bottom line of the display and press **OK**.
2. Press **OK** when **Machine Setup** appears.
3. Press the left/right arrow until **Date & Time** appears and press **OK**.
4. Enter the correct time and date using the number keypad.
Month = 01 to 12
Day = 01 to 31
Year = requires four digits
Hour = 01 to 12 (12-hour mode)
 00 to 23 (24-hour mode)
Minute = 00 to 59

 The date format may differ from country to country

You can also use the left/right arrow to move the cursor under the digit you want to correct and enter a new number.

5. To select **AM** or **PM** for 12-hour format, press the * or # button or any number button.
When the cursor is not under the AM or PM indicator, pressing the * or # button immediately moves the cursor to the indicator.
You can change the clock mode to 24-hour format (e.g. 01:00 PM as 13:00). For details, see the next section.
6. Press **OK** to save the time and date.
When you enter a wrong number, **Out of Range** appears and the machine does not proceed to the next step. If this happens, simply reenter the correct number.
7. Press **Stop/Clear** to return to ready mode.

Changing the clock mode

You can set your machine to display the current time using either a 12-hour or 24-hour format.

1. Press **Menu** until **System Setup** appears on the bottom line of the display and press **OK**.
2. Press **OK** when **Machine Setup** appears.
3. Press the left/right arrow until **Clock Mode** appears and press **OK**.
4. Press the left/right arrow to select the other mode and press **OK**.
5. Press **Stop/Clear** to return to ready mode.

Changing the default mode

Your machine is preset to Fax mode. You can switch this default mode between Fax mode and Copy mode.

1. Press **Menu** until **System Setup** appears on the bottom line of the display and press **OK**.
2. Press **OK** when **Machine Setup** appears.
3. Press the left/right arrow until **Default Mode** appears and press **OK**.
4. Press the left/right arrow until the default mode you want appears and press **OK**.
5. Press **Stop/Clear** to return to ready mode.

Setting sounds

You can control the following sounds:

- **Key Sound:** Turns the key sound on or off. With this option set to **On**, a tone sounds each time a key is pressed.
- **Alarm Sound:** Turns the alarm sound on or off. With this option set to **On**, an alarm tone sounds when an error occurs or fax communication ends.
- **Speaker:** Turns on or off the sounds from the telephone line through the speaker, such as a dial tone or a fax tone. With this option set to **Comm.** which means “Common,” the speaker is on until the remote machine answers.
 You can adjust the volume level using **On Hook Dial**.
- **Ringer** : Adjusts the ringer volume. For the ringer volume, you can select **Off**, **Low**, **Mid**, and **High**.

Speaker, ringer, key sound, and alarm sound

1. Press **Menu** until **System Setup** appears on the bottom line of the display and press **OK**.
2. Press the left/right arrow until **Sound/Volume** appears and press **OK**.
3. Press the left/right arrow until the sound option you want appears and press **OK**.
4. Press the left/right arrow until the desired status or volume for the sound you have selected appears and press **OK**.
5. If necessary, repeat steps 3 through 5 to set other sounds.
6. Press **Stop/Clear** to return to ready mode.

Speaker volume

1. Press **On Hook Dial**. A dial tone sounds from the speaker.
2. Press the left/right arrow until you hear the volume you want.
3. Press **Stop/Clear** to save the change and return to ready mode.

 You can adjust the speaker volume only when the telephone line is connected.

Entering characters using the number keypad

As you perform various tasks, you may need to enter names and numbers. For example, when you set up your machine, you enter your name or your company's name, and the fax number. When you store fax numbers or email addresses in memory, you may also enter the corresponding names.

Entering alphanumeric characters

1. When you are prompted to enter a letter, locate the button labeled with the character you want. Press the button until the correct letter appears on the display.
For example, to enter the letter **O**, press **6**, labeled with **MNO**. Each time you press **6**, the display shows a different letter, **M**, **N**, **O**, **m**, **n**, **o** and finally **6**.
You can enter special characters, such as space, plus sign, and etc. For details, see the below section.
2. To enter additional letters, repeat step 1.
If the next letter is printed on the same button, move the cursor by pressing the right left/right arrow button and then press the button labeled with the letter you want. The cursor will move to the right and the next letter will appear on the display.
You can enter a space by pressing **1** twice.
3. When you have finished entering letters, press **OK**.

Keypad letters and numbers

KEY	ASSIGNED NUMBERS, LETTERS, OR CHARACTERS
1	1 Space
2	A B C a b c 2
3	D E F d e f 3
4	G H I g h i 4
5	J K L j k l 5
6	M N O m n o 6
7	P Q R S p q r s 7
8	T U V t u v 8
9	W X Y Z w x y z 9
0	+ - , . ' / * # & @ 0

Correcting numbers or names

If you make a mistake while entering a number or name, press the left left/right arrow button to delete the last digit or character. Then enter the correct number or character.

Inserting a pause

With some telephone systems, you must dial an access code (9, for example) and listen for a second dial tone. In such cases, you must insert a pause in the telephone number. You can insert a pause while you are setting up speed buttons or speed dial numbers.

To insert a pause, press **Redial/Pause** at the appropriate place while entering the telephone number. A - appears on the display at the corresponding location.

Using the save modes

Power Save mode

Power Save mode allows your machine to reduce power consumption when it is not in actual use. You can turn this mode on and select a length of time for which the machine waits after a job is printed before it switches to a reduced power state.

1. Press **Menu** until **System Setup** appears on the bottom line of the display and press **OK**.
2. Press **OK** when **Machine Setup** appears.
3. Press the left/right arrow until **Power Save** appears and press **OK**.
4. Press the left/right arrow until the time setting you want appears and press **OK**.
5. Press **Stop/Clear** to return to ready mode.

Scan Power Save mode

Scan Power Save mode allows you to save power by turning off the scan lamp. The scan lamp under the scanner glass automatically turns off when it is not in actual use to reduce power consumption and extend the life of the lamp. The lamp automatically wakes up after some warm-up time when you start scanning.

You can set the length of time for which the scan lamp waits after a scan job is completed before it switches to the power save mode.

1. Press **Menu** until **System Setup** appears on the bottom line of the display and press **OK**.
2. Press **OK** when **Machine Setup** appears.
3. Press the left/right arrow until **Scan PWR Save** appears and press **OK**.
4. Press the left/right arrow until the time setting you want appears and press **OK**.
5. Press **Stop/Clear** to return to ready mode.

Setting print job timeout

You can set the amount of time a single print job is active before it must print. The machine handles incoming data as a single job if it comes in within the specified time. When an error occurs while processing data from the computer and the data flow stops, the machine waits the specified time and then cancels printing if data flow does not resume.

1. Press **Menu** until **System Setup** appears on the bottom line of the display and press **OK**.
2. Press **OK** when **Machine Setup** appears.
3. Press the left/right arrow until **Job Timeout** appears and press **OK**.
4. Press the left/right arrow until the time setting you want appears and press **OK**.
5. Press **Stop/Clear** to return to ready mode.

Auto continue

This is the option to set the machine to continue printing or not, in case the paper size you have set and the paper within the tray mismatches.

1. Press **Menu** until **System Setup** appears on the bottom line of the display and press **OK**.
2. Press **OK** when **Machine Setup** appears.
3. Press the left/right arrow until **Auto Continue** appears and press **OK**.
4. Press the left/right arrow until the binding option you want appears.
 - **On:** Automatically prints after set time passes, when the paper size mismatches the tray paper size.
 - **Off:** Waits until you press **Black Start** or **Color Start** on the control panel, when the paper size mismatches the tray paper size.
5. Press **OK** to save your selection.
6. Press **Stop/Clear** to return to ready mode.

Net accounting

Net Accounting function limits the number of use for fax, printer, copy and scan. First, user need to install Net account Plug-in from **SyncThru™ Web Admin Service**. Create user account by entering user ID and Password in **SyncThru™ Web Admin Service**.

If you are not registered, request Administrator for a registration. (See page 26)

1. Press **Menu** until **System Setup** appears on the bottom line of the display and press **OK**.
2. Press **OK** when **Machine Setup** appears.
3. Press the left/right arrow until **Net Accounting** appears and press **OK**.
4. Press the left/right arrow until the option you want appears and press **OK**.
 - **Protect:** Select the option for which you want to enable or disable **Net Accounting**.
 - **Chg.Password:** The access password code can be changed.
5. Press **Stop/Clear** to return to ready mode.

Changing the font setting

Your machine has preset the font for your region or country.

If you want to change the font or set the font for special condition such as the DOS environment, you can change the font setting as follows:

1. Ensure that you have installed the printer driver from the provided software CD.
2. Double-click the **Smart Panel** icon on the Windows task bar (or Notification Area in Linux). You can also click **Smart Panel** on the status bar in Mac OS X.
3. Click **Printer Setting**.
4. Click **Emulation**.
5. Confirm if **PCL** is selected in **Emulation Setting**.
6. Click **Setting**.
7. Select your preferred font in the **Symbol set** list.
8. Click **Apply**.



Following information shows the proper font list for corresponding languages.

- Russian: CP866, ISO 8859/5 Latin Cyrillic
- Hebrew: Hebrew 15Q, Hebrew-8, Hebrew-7 (Israel only)
- Greek: ISO 8859/7 Latin Greek, PC-8 Latin/Greek
- Arabic & Farsi: HP Arabic-8, Windows Arabic, Code Page 864, Farsi, ISO 8859/6 Latin Arabic
- OCR : OCR-A, OCR-B

loading originals and print media

This chapter introduces you how to load originals and print media into your machine.

This chapter includes:

- Loading originals
- Selecting print media
- Changing the size of the paper in the paper tray

LOADING ORIGINALS

You can use the scanner glass or DADF (or ADF) to load an original for copying, scanning, and sending a fax.

- The MFX-C2500 has the DADF function which can let you scan on both sides of the original media at once. See "Scan on both sides of paper" on page 48.

On the scanner glass

Make sure that no originals are in the DADF (or ADF). If an original is detected in the DADF (or ADF), the machine gives it priority over the original on the scanner glass. To get the best scan quality, especially for colored or gray-scaled images, use the scanner glass.

1. Lift and open the scanner lid.

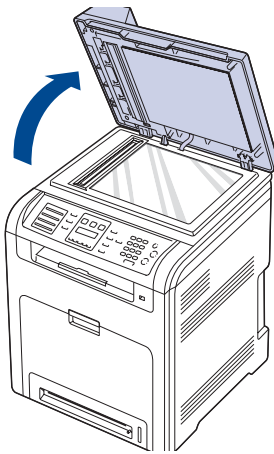

- Loading paper
- Adjusting the output support
- Setting the paper size and type

2. Place the original face down on the scanner glass and align it with the registration guide at the top left corner of the glass.

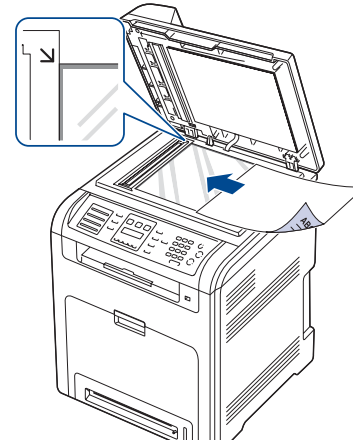

3. Close the scanner lid.

- Leaving the scanner lid open while copying may affect copy quality and toner consumption.
- Dust on the scanner glass may cause black spots on the printout. Always keep it clean.
- If you are copying a page from a book or magazine, lift the scanner lid until its hinges are caught by the stopper and then close the lid. If the book or magazine is thicker than 30 mm, start copying with the lid open.

In the DADF

Using the DADF, you can load up to 50 sheets of paper (75 g/m², 20 lb bond) for one job.

When you use the DADF:

- In the DADF: Do not load paper smaller than 148 x 148 mm (5.8 x 5.8 inches) or larger than 216 x 356 mm (8.5 x 14 inches).
- Do not attempt to load the following types of paper:
 - carbon-paper or carbon-backed paper
 - coated paper
 - onion skin or thin paper
 - wrinkled or creased paper
 - curled or rolled paper
 - torn paper
- Remove all staples and paper clips before loading.
- Make sure any glue, ink, or correction fluid on the paper is completely dry before loading.
- Do not load originals that include different sizes or weights of paper.

- Do not load booklets, pamphlets, transparencies, or documents having other unusual characteristics.
1. Flex or fan the edge of the paper stack to separate the pages before loading originals.

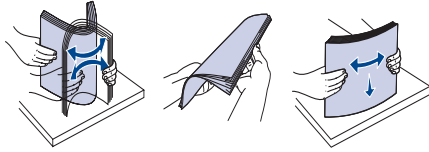

2. Load the original face up into the DADF. Make sure that the bottom of the original stack matches the paper size marked on the document input tray.

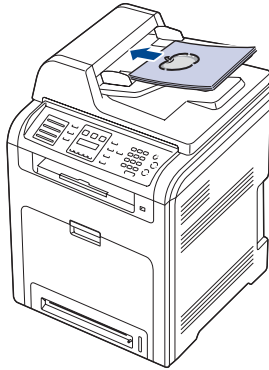

3. Adjust the document width guides to the paper size.

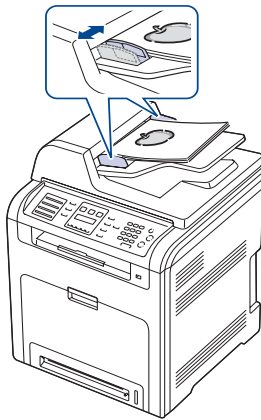

- ☞ Dust on the DADF glass may cause black lines on the printout. Always keep it clean.

SELECTING PRINT MEDIA

You can print on a variety of print media, such as plain paper, envelopes, labels, and transparencies. Always use print media that meet the guidelines for use with your machine. Print media that does not meet the guidelines outlined in this user's guide may cause the following problems:

- Poor print quality
- Increased paper jams
- Premature wear on the machine.

Properties, such as weight, composition, grain, and moisture content, are important factors that affect the machine's performance and the output quality. When you choose print materials, consider the following:

- The type, size and weight of the print media for your machine are described later in this section.
- Desired outcome: The print media you choose should be appropriate for your project.
- Brightness: Some print media are whiter than others and produce sharper, more vibrant images.
- Surface smoothness: The smoothness of the print media affects how crisp the printing looks on the paper.
- ☞ Some print media may meet all of the guidelines in this section and still not produce satisfactory results. This may be the result of improper handling, unacceptable temperature and humidity levels, or other variables over which Samsung has no control.
- Before purchasing large quantities of print media, ensure that it meets the requirements specified in this user's guide.

- ⚠ Using print media that does not meet these specifications may cause problems, requiring repairs. Such repairs are not covered by Samsung's warranty or service agreements.

Specifications on print media

TYPE	SIZE	DIMENSIONS	WEIGHT ^A	CAPACITY ^B
Plain paper	Letter	216 x 279 mm (8.5 x 11 inches)	<ul style="list-style-type: none"> 60 to 105 g/m² (16 to 28 lb bond) for the tray 60 to 163 g/m² (16 to 43 lb bond) for the multi-purpose tray 	<ul style="list-style-type: none"> 250 sheets of 75 g/m² (20 lb bond) paper for the tray 100 sheets of 75 g/m² (20 lb bond) in the multi-purpose tray 500 sheets of 75 g/m² (20 lb bond) paper for optional tray
	Legal	216 x 356 mm (8.5 x 14 inches)		
	US Folio	216 x 330 mm (8.5 x 13 inches)		
	A4	210 x 297 mm (8.26 x 11.69 inches)		
	Oficio	216 x 343 mm (8.5 x 13.5 inches)		
	JIS B5	182 x 257 mm (7.16 x 10.11 inches)		
	ISO B5	176 x 250 mm (6.93 x 9.84 inches)		
	Executive	184 x 267 mm (7.25 x 10.5 inches)		
	A5	148 x 210 mm (5.82 x 8.26 inches)		
	Statement	140 x 216 mm (5.5 x 8.5 inches)		
	A6	105 x 148 mm (4.13 x 5.82 inches)		
Envelope	Envelope Monarch	98 x 191 mm (3.87 x 7.5 inches)	75 to 105 g/m ² (20 to 28 lb bond)	10 sheets of 75 g/m ² (20 lb bond) in the multi-purpose tray
	Envelope 6 3/4	92 x 165 mm (3.62 x 6.5 inches)		
	Envelope No. 10	105 x 241 mm (4.12 x 9.5 inches)		
	Envelope No. 9	98 x 225 mm (3.87 x 8.87 inches)		
	Envelope DL	110 x 220 mm (4.33 x 8.66 inches)		
	Envelope C5	162 x 229 mm (6.37 x 9.01 inches)		
	Envelope C6	114 x 162 mm (4.48 x 6.38 inches)		
Labels	Letter, Legal, US Folio, A4, JIS B5, ISO B5, Executive, A5, Statement	Refer to the Plain paper section	120 to 150 g/m ² (32 to 40 lb bond)	10 sheets of 75 g/m ² (20 lb bond) paper for the multi-purpose tray
Card stock	Letter, Legal, US Folio, A4, JIS B5, ISO B5, Executive, A5, Statement	Refer to the Plain paper section	90 to 163 g/m ² (24 to 43 lb bond)	10 sheets of 75 g/m ² (20 lb bond) paper for the multi-purpose tray
Minimum size (custom)		76 x 127 mm (3 x 5 inches)	60 to 163 g/m ² (16 to 43 lb bond)	
Maximum size (custom)		216 x 356 mm (8.5 x 14 inches)		

a. If media weight is over 105 g/m² (28 lb bond), use the multi-purpose tray.

b. Maximum capacity may differ depending on media weight, thickness, and environmental conditions.

Media sizes supported in each mode

MODE	SIZE	SOURCE
Copy mode	Letter, A4, Legal, Oficio, US Folio, Executive, JIS B5, A5, A6	<ul style="list-style-type: none"> tray 1 optional tray 2 multi-purpose tray
Print mode	All sizes supported by the machine	<ul style="list-style-type: none"> tray 1 optional tray 2 multi-purpose tray
Fax mode	Letter, A4, Legal	<ul style="list-style-type: none"> tray 1 optional tray 2
Duplex printing*	Letter, A4, Legal, US Folio, Oficio	<ul style="list-style-type: none"> tray 1 optional tray 2 multi-purpose tray

*75 to 105 g/m² (20~28 lb bond) only

Guidelines for special print media

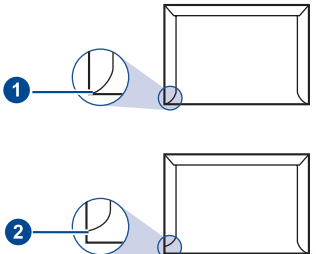
MEDIA TYPE	GUIDELINES
Envelopes	<ul style="list-style-type: none"> Successful printing on envelopes depends upon the quality of the envelopes. When selecting envelopes, consider the following factors: <ul style="list-style-type: none"> Weight: The weight of the envelope paper should not exceed 90 g/m² or jamming may occur. Construction: Prior to printing, envelopes should lie flat with less than 6 mm curl, and should not contain air. Condition: Envelopes should not be wrinkled, nicked, or otherwise damaged. Temperature: You should use envelopes that are compatible with the heat and pressure of the machine during operation. Use only well-constructed envelopes with sharp and well creased folds. Do not use stamped envelopes. Do not use envelopes with clasps, snaps, windows, coated lining, self-adhesive seals, or other synthetic materials. Do not use damaged or poorly made envelopes. Be sure the seam at both ends of the envelope extends all the way to the corner of the envelope.  <p>1 Acceptable 2 Unacceptable</p>

MEDIA TYPE	GUIDELINES
	<ul style="list-style-type: none"> Envelopes with a peel-off adhesive strip or with more than one flap that folds over to seal must use adhesives compatible with the machine's fusing temperature for 0.1 second. Check your machine's specification to view the fusing temperature, see page 99. The extra flaps and strips might cause wrinkling, creasing, or jams, and may even damage the fuser. For the best print quality, position margins no closer than 15 mm from the edges of the envelope. Avoid printing over the area where the envelope's seams meet.
Labels	<ul style="list-style-type: none"> To avoid damaging the machine, use only labels designed for use in laser machines. <ul style="list-style-type: none"> When selecting labels, consider the following factors: <ul style="list-style-type: none"> Adhesives: The adhesive material should be stable at your machine's fusing temperature. Check your machine's specification to view the fusing temperature, see page 98. Arrangement: Only use labels with no exposed backing between them. Labels can peel off sheets that have spaces between the labels, causing serious jams. Curl: Prior to printing, labels must lie flat with no more than 13 mm of curl in any direction. Condition: Do not use labels with wrinkles, bubbles, or other indications of separation. Make sure that there is no exposed adhesive material between labels. Exposed areas can cause labels to peel off during printing, which can cause paper jams. Exposed adhesive can also cause damage to machine components. Do not run a sheet of labels through the machine more than once. The adhesive backing is designed for only a single pass through the machine. Do not use labels that are separating from the backing sheet or are wrinkled, bubbled, or otherwise damaged.
Card stock or custom-sized materials	<ul style="list-style-type: none"> Do not print on media smaller than 76 mm wide or 356 mm long. In the software application, set margins at least 6.4 mm away from the edges of the material.
Preprinted paper	<ul style="list-style-type: none"> Letterhead must be printed with heat-resistant ink that will not melt, vaporize, or release hazardous emissions when subjected to the printer's fusing temperature for 0.1 second. Check your machine's specification to view the fusing temperature, see page 98. Letterhead ink must be non-flammable and should not adversely affect printer rollers. Forms and letterhead should be sealed in a moisture-proof wrapping to prevent changes during storage. Before you load preprinted paper, such as forms and letterhead, verify that the ink on the paper is dry. During the fusing process, wet ink can come off preprinted paper, reducing print quality.

CHANGING THE SIZE OF THE PAPER IN THE PAPER TRAY

To load longer sizes of paper, such as Legal-sized paper, you need to adjust the paper guides to extend the paper tray.

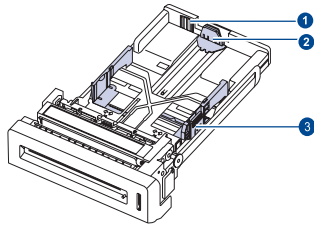

- 1 Tray extend lever
- 2 Paper length guide
- 3 Paper width guide

1. Adjust the paper length guide to the desired paper length. It is preset to Letter or A4 size depending on the country.

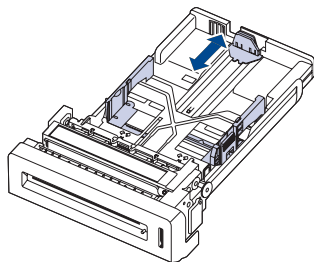

2. After inserting paper into the tray, while pinching the paper width guide as shown, move it toward the stack of paper until it lightly touches the side of the stack. Do not press the guide too tightly to the edge of the paper; the guide may bend the paper.

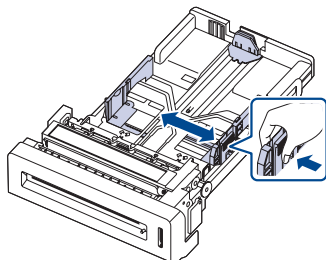

When you use legal-sized paper, you need to extend the length of the tray.

3. Press and hold the green lever on the back of the tray, when you are holding the lever, extend the tray to the corresponding position.

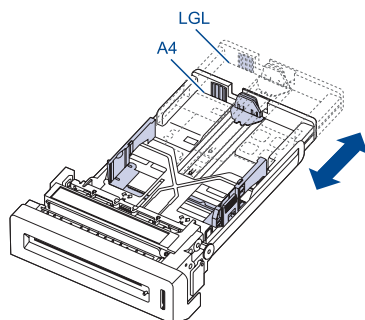

4. Load the paper into the tray.

5. Place the tray into the machine.
6. Set the paper size from your computer.

- Do not push the paper width guides far enough to cause the materials to warp.
- If you do not adjust the paper width guides, it may cause paper jams.

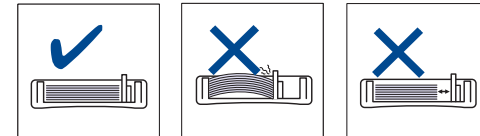

LOADING PAPER

Loading paper in the tray 1 or optional tray

Load the print media you use for the majority of your print jobs in the tray 1. The tray 1 can hold a maximum of 250 sheets of 75 g/m² (20 lb bond) plain paper.

You can purchase an optional tray and attach it below the standard tray to load an additional 500 sheets of paper. (See "" on page 90.)

- Using photographic paper or coated paper may cause problems, requiring repairs. Such repairs are not covered by Muratec's warranty or service agreements.

1. To load paper, pull and open the paper tray and place paper with the side you want to print facing up.

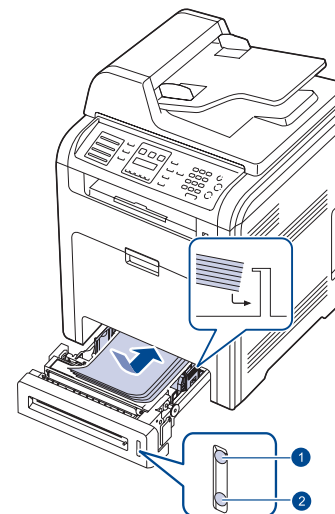

- 1 Full
- 2 Empty

2. After loading paper, set the paper type and size for the tray 1. See *Software section* for PC-printing.

- If you experience problems with paper feed, place one sheet at a time in the multi-purpose tray.
- You can load previously printed paper. The printed side should be facing down with an uncurled edge at the front. If you experience problems with paper feed, turn the paper around. Note that print quality is not guaranteed.

Loading paper in the multi-purpose tray

The multi-purpose tray can hold special sizes and types of print material, such as postcards, note cards, and envelopes. It is useful for single page printing on letterhead or colored paper.

Tips on using the multi-purpose tray

- Load only one size of print media at a time in the multi-purpose tray.
 - To prevent paper jams, do not add paper when there is still paper in the multi-purpose tray. This also applies to other types of print media.
 - Print media should be loaded face down with the top edge going into the multi-purpose tray first and be placed in the center of the tray.
 - Always load only the specified print media to avoid paper jams and print quality problems. (See "Selecting print media" on page 33.)
 - Flatten any curl on postcards, envelopes, and labels before loading them into the multi-purpose tray.
1. Hold the handle of multi-purpose tray and pull it down to open.

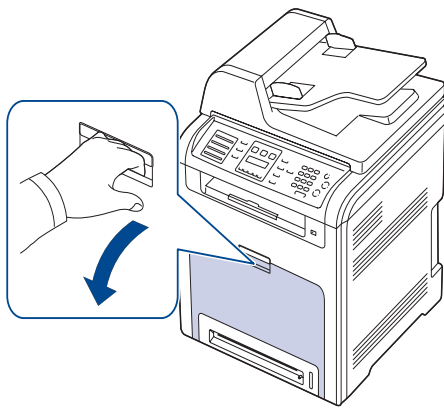

2. Load the paper.

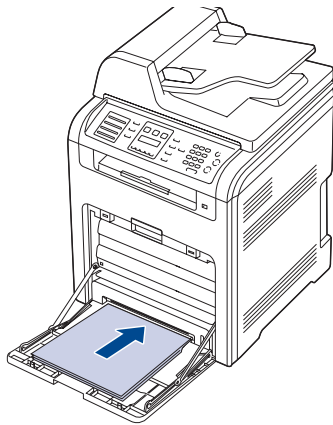

- If you want to load the used paper, place the paper with the printed side facing down.
- If you are using paper, flex or fan the edge of the paper stack to separate the pages before loading.

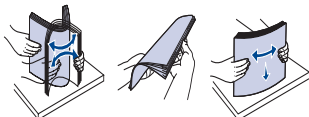

3. Squeeze the multi-purpose tray paper width guides and adjust them to the width of the paper. Do not force too much, or the paper will be bent, which will result in a paper jam or skew.

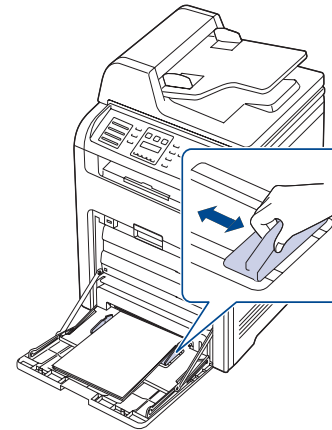

- Depending on the media type you are using, keep the following loading guidelines:
 - Envelopes: Flap side down and with the stamp area on the top left side.
 - Labels: Print side up and top short edge entering the machine first.
 - Preprinted paper: Design side up with the top edge toward the machine.
 - Card stock: Print side up and the short edge entering the machine first.
 - Previously printed paper: Previously printed side down with an uncurled edge toward the machine.
4. After loading paper, set the paper type and size for the multi-purpose tray. See *Software section* for PC-printing.
 - The settings made from the printer driver override the settings on the control panel.
 5. After printing, close the multi-purpose tray.

ADJUSTING THE OUTPUT SUPPORT

The printed pages stack on the output tray, and the output support will help the printed pages to align. For the output support to correctly align the pages, you need to pull it out appropriately depending on the paper size.

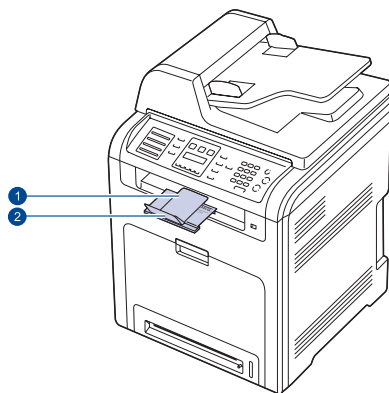

- 1 Output support
- 2 Extension

-  • If the output support is incorrectly adjusted, printed pages may be mis-aligned or fall.
- If you continuously print many pages, the surface of the output tray may become hot. Be careful not to touch the surface, and especially keep out of children's reach.

For Letter-sized paper

Pull out the output support to the location indicated LTR as shown, and unfold the extension.

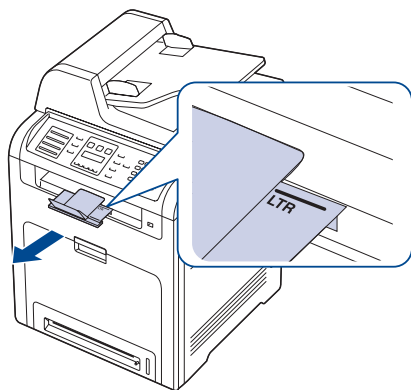

For A4- or Legal-sized paper

Pull out the output support to the location indicated A4, LGL as shown, and unfold the extension.

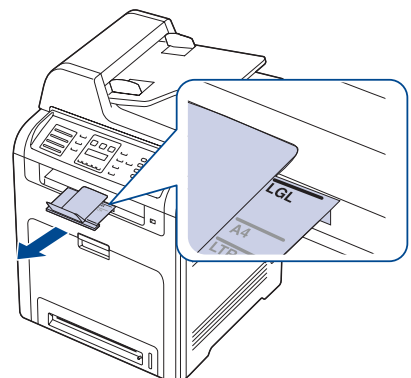

SETTING THE PAPER SIZE AND TYPE

After loading paper in the paper tray, you need to set the paper size and type using the control panel buttons. These settings will apply to Copy and Fax modes. For PC-printing, you need to select the paper size and type in the application program you use on your PC.

1. Press **Menu** until **System Setup** appears on the bottom line of the display and press **OK**.
2. Press the left/right arrow until **Paper Setup** appears and press **OK**.
3. Press **OK** when **Paper Size** appears.
4. Press the left/right arrow until the paper tray you want appears and press **OK**.
5. Press the left/right arrow until the paper size you are using appears and press **OK**.
6. Press **Back** to return to the upper level.
7. Press the left/right arrow until **Paper Type** appears and press **OK**.
8. Press the left/right arrow until the paper type you are using appears and press **OK**.
9. Press **Stop/Clear** to return to ready mode.

-  If you want to use special sized paper such as a billing paper, select **Custom** in the **Paper** tab in the printer properties. See **Software section**.

copying

This chapter gives you step-by-step instructions for copying documents.

This chapter includes:

- Selecting the paper tray
- Copying
- Changing the settings for each copy
- Changing the scan size settings
- Changing the default copy settings

SELECTING THE PAPER TRAY

After loading the print media for copy output, you must select the paper tray you will use for copy jobs.

1. Press **Menu** until **System Setup** appears on the bottom line of the display and press **OK**.
2. Press the left/right arrow until **Paper Setup** appears and press **OK**.
3. Press the left/right arrow until **Paper Source** appears and press **OK**.
4. Press **OK** when **Copy Tray** appears.
5. Press the left/right arrow until the paper tray you want appears and press **OK**.
6. Press **Stop/Clear** to return to ready mode.

COPYING

1. Press **Copy**.
Ready to Copy appears on the top line of the display.
 2. Load originals face up into the DADF, or place a single original face down on the scanner glass.
For details about loading an original, see page 32.
 3. Enter the number of copies using the number keypad, if necessary.
 4. If you want to customize the copy settings including copy size, darkness, and original type, by using the control panel buttons. See page 39.
If necessary, you can use special copy features, such as poster copying, 2- or 4-up copying. See page 40.
 5. Press **Color Start** to begin color copying.
Or, press **Black Start** to begin black and white copying.
-  You can cancel the copy job during an operation. Press **Stop/Clear**, and the copying will stop.

CHANGING THE SETTINGS FOR EACH COPY

Your machine provides default settings for copying so that you can quickly and easily make a copy. However, if you want to change the options for each copy, use the copy function buttons on the control panel.

-  If you press **Stop/Clear** while setting the copy options, all of the options you have set for the current copy job will be canceled and returned to their default status. Or, they will automatically return to their default status after the machine completes the copy in progress.

- ID card copying
- Using special copy features
- Printing on both sides of paper
- Setting copy timeout

Darkness

If you have an original containing faint markings and dark images, you can adjust the brightness to make a copy that is easier to read.

To adjust the darkness of copies, press **Darkness**. Each time you press the button, the following modes are available:

- **Lightest:** Works well with darker print.
- **Light:** Works well with dark print.
- **Normal:** Works well with standard typed or printed originals.
- **Dark:** Works well with light print.
- **Darkest:** Works well with lighter print or faint pencil markings.

Original Type

The original type setting is used to improve the copy quality by selecting the document type for the current copy job.

To select the document type, press **Original Type**. Each time you press the button, the following modes are available:

- **Text:** Use for originals containing mostly text.
- **Text/Photo:** Use for originals with mixed text and photographs.
- **Photo:** Use when the originals are photographs.
- **Magazine:** Use when the originals are magazines.

Reduced or enlarged copy

By using the **Reduce/Enlarge** button, you can reduce or enlarge the size of a copied image from 25% to 400% when you copy original documents from the scanner glass, or from 25% to 100% from the DADF.

To select from the predefined copy sizes:

1. Press **Reduce/Enlarge**.
2. Press **Reduce/Enlarge** or the left/right arrow until the size setting you want appears and press **OK**.

To scale the copy by directly entering the scale rate:

1. Press **Reduce/Enlarge**.
2. Press **Reduce/Enlarge** or the left/right arrow until **Custom** appears and press **OK**.
3. Enter the scale rate and press **OK** to save the selection.

-  When you make a reduced copy, black lines may appear at the bottom of your copy.

CHANGING THE SCAN SIZE SETTINGS

You can adjust the scan size for the original paper. For example, if you scan a A4-sized original and set the scan size to A5, the machine scans only the area of A5 (148 x 210 mm). We recommend you to change the right scan size for the original paper.

After loading the print media for copy output, you need to set the scan size using the control panel buttons.

1. Press **Copy**.
2. Press **Menu** until **Copy Setup** appears on the bottom line of the display and press **OK**.
3. Press **OK** when **Scan Size** appears.
4. Press the left/right arrow until the setting you want appears and press **OK**.
5. Press **Stop/Clear** to return to ready mode.

 After using this option, the machine automatically resumes to the default setting.

CHANGING THE DEFAULT COPY SETTINGS

The copy options, including darkness, original type, copy size, and number of copies, can be set to those most frequently used. When you copy a document, the default settings are used unless they have been changed by using the corresponding buttons on the control panel.

1. Press **Copy**.
2. Press **Menu** until **Copy Setup** appears on the bottom line of the display and press **OK**.
3. Press **OK** when **Change Default** appears.
4. Press the left/right arrow until the setup option you want appears and press **OK**.
5. Press the left/right arrow until the setting you want appears and press **OK**.
6. Repeat steps 4 through 5, as needed.
7. Press **Stop/Clear** to return to ready mode.

 While you are setting copy options, pressing **Stop/Clear** cancels the changed settings and restores the defaults.

ID CARD COPYING



Your machine can print 2-sided originals on one sheet of A4-, Letter-, Legal-, Folio-, Oficio-, Executive-, B5-, A5-, or A6-sized paper.

When you copy using this feature, the machine prints one side of the original on the upper half of the paper and the other side on the lower half without reducing the size of the original. This feature is helpful for copying a small-sized item, such as a name card.

This copy feature is available only when you place originals on the scanner glass.

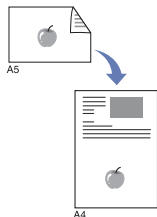
1. Press **ID Copy**.
2. Place a single original face down on the scanner glass. For details about loading an original, see page 32.
3. **Place Front Side and Press[Start]** appears on the display.
4. Press **Color Start** or **Black Start**.
Your machine begins scanning the front side and shows **Place Back Side and Press[Start]**



5. Open the scanner lid and turn the original over.
 If you press **Stop/Clear** or if no buttons are pressed for approximately 30 seconds, the machine cancels the copy job and returns to ready mode.
6. Press **Color Start** to begin color copying.
Or, press **Black Start** to begin black and white copying
 If the original is larger than the printable area, some portions may not be printed.
If you press **Stop/Clear** or if no buttons are pressed for approximately 30 seconds, the machine cancels the copy job and returns to ready mode.

USING SPECIAL COPY FEATURES

You can use the following copy features:

Collation

You can set the machine to sort the copy job. For example, if you make 2 copies of a 3 page original, one complete 3 page document will print followed by a second complete document.

1. Press **Copy**.
2. Load originals face up into the DADF, or place a single original face down on the scanner glass. For details about loading an original, see page 32.
3. Enter the number of copies using the number keypad.
4. Press **Menu** until **Copy Feature** appears on the bottom line of the display and press **OK**.
5. Press **OK** when **Copy Collation** appears.
6. Press the left/right arrow to select the color mode you want.

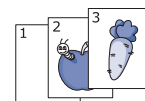
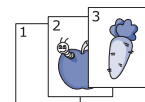

There are two types of mode as following:

- **Yes-Color:** Color copy
 - **Yes-Mono:** Black and White copy
7. Press **OK** to begin copying.
One complete document will print followed by the second complete document.

2-up or 4-up copying

Your machine can print 2 or 4 original images reduced to fit onto one sheet of paper.

1. Press **Copy**.
2. Load originals face up into the DADF, or place a single original face down on the scanner glass. For details about loading an original, see page 32.
3. Press **Menu** until **Copy Feature** appears on the bottom line of the display and press **OK**.
4. Press the left/right arrow until **2-Up** or **4-Up** appears and press **OK**.
5. Press the left/right arrow to select the color mode you want.

There are two types of mode as following:

- **Yes-Color:** Color copy
 - **Yes-Mono:** Black and White copy
6. Press **OK** to begin copying.
 You cannot adjust the copy size using the **Reduce/Enlarge** button for making a 2- or 4-up copy.

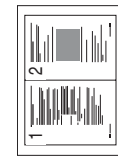

Poster copying

Your machine can print an image onto 9 sheets of paper (3x3). You can paste the printed pages together to make one poster-sized document. This copy feature is available only when you place originals on the scanner glass.

1. Press **Copy**.
2. Place a single original face down on the scanner glass.
For details about loading an original, see page 32.
3. Press **Menu** until **Copy Feature** appears on the bottom line of the display and press **OK**.
4. Press the left/right arrow until **Poster Copy** appears and press **OK**.
5. Press the left/right arrow to select the color mode you want.
There are two types of mode as following:
 - **Yes-Color:** Color copy
 - **Yes-Mono:** Black and White copy
6. Press **OK** to begin copying.

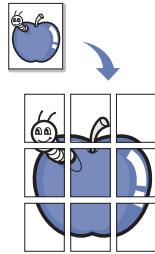

Your original is divided into 9 portions. Each portion is scanned and printed one by one in the following order:

1	2	3
4	5	6
7	8	9

Clone copying

Your machine can print multiple image copies from the original document on a single page. The number of images is automatically determined by the original image and paper size.

This copy feature is available only when you place originals on the scanner glass.

1. Press **Copy**.
2. Place a single original face down on the scanner glass.
For details about loading an original, see page 32.
3. Press **Menu** until **Copy Feature** appears on the bottom line of the display and press **OK**.
4. Press the left/right arrow until **Clone Copy** appears and press **OK**.
5. Press the left/right arrow to select the color mode you want.
There are two types of mode as following:
 - **Yes-Color:** Color copy
 - **Yes-Mono:** Black and White copy
6. Press **OK** to begin copying.

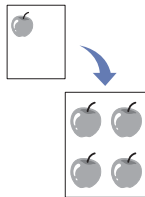

 You cannot adjust the copy size using the **Reduce/Enlarge** button while making a clone copy.

Adjusting background images

You can set the machine to print an image without its background. This copy feature removes the background color and can be helpful when copying an original containing color in the background, such as a newspaper or a catalog.

1. Press **Copy**.
2. Load originals face up into the DADF, or place a single original face down on the scanner glass.
For details about loading an original, see page 32.
3. Press **Menu** until **Copy Feature** appears on the bottom line of the display and press **OK**.

4. Press the left/right arrow until **Adjust Bkgd.** appears and press **OK**.
5. Press the left/right arrow until the binding option you want appears.
 - **Off:** Does not use this feature.
 - **Auto:** Optimizes the background.
 - **Enhance Lev. 1~2:** The higher the number is, the more vivid the background is.
 - **Erase Lev. 1~4:** The higher the number is, the lighter the background is.
6. Press **OK** to begin copying.
7. Press **Stop/Clear** to return to ready mode.

Book copying

The **Book Copy** feature allows you to copy an entire book. If the book is too thick, lift the cover until its hinges are caught by the stopper and then close the cover. If the book or magazine is thicker than 30 mm, start copying with the cover open.

1. Press **Copy**.
2. Place a single original face down on the scanner glass.
For details about loading an original, see page 32.
3. Press **Menu** until **Copy Feature** appears on the bottom line of the display and press **OK**.
4. Press **OK** when **Book Copy** appears.
5. Press the left/right arrow until the binding option you want appears.

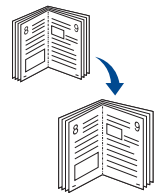

- **Off:** Does not use this feature.
 - **Left Page:** Use this option to print left page of the book.
 - **Right Page:** Use this option to print right page of the book.
 - **Both Page:** Use this option to print both pages of the book.
6. Press the left/right arrow to select the color mode you want.
There are two types of mode as following:
 - **Yes-Color:** Color copy
 - **Yes-Mono:** Black and White copy
 7. Press **OK** to begin copying.

Margin shift

The **Margin Shift** feature allows you to create a binding edge for the document. The image can be adjusted up or down on the page and/or shifted to the right or left.

-  The Margin Shift feature can either be used for Scan glass or DADF depending on the set up.
- Auto Center:** Scanner glass
 - Custom Margin:** Scanner glass, DADF

1. Press **Copy**.
2. Load originals face up into the DADF, or place a single original face down on the scanner glass.
For details about loading an original, see page 32.
3. Press **Menu** until **Copy Feature** appears on the bottom line of the display and press **OK**.
4. Press **OK** when **Margin Shift** appears.
5. Press the left/right arrow until the binding option you want appears.
 - **Off:** This feature is disabled.
 - **Auto Center:** Automatically copy in the center of the paper.
 - **Custom Margin:** Enter the left, right, top, bottom margin using Number keypad.
6. Press the left/right arrow to select **Yes**.

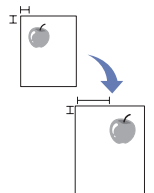

- Press **OK** to begin copying.
- Press **Stop/Clear** to return to ready mode.

Edge erase

Edge erase allows you to erase sports, drill holes, fold creases and staple marks along any of the four edges of a document.

 The **Edge Erase** feature can either be used for scan glass or DADF depending on the set up.

- Small Original**: Scanner glass
- Hole Punch**: Scanner glass, DADF
- Book Center**: Scanner glass
- Border Erase**: Scanner glass, DADF

- Press **Copy**.
- Load originals face up into the DADF, or place a single original face down on the scanner glass.
For details about loading an original, see page 32.
- Press **Menu** until **Copy Feature** appears on the bottom line of the display and press **OK**.
- Press **OK** when **Edge Erase** appears.
- Press the left/right arrow until the binding option you want appears.
 - **Off**: Does not set the binding option.
 - **Small Original**. Erases the edge of the original if it is small.
 - **Hole Punch**. Erases the marks of bookbinding holes.
 - **Book Center**. Erases the middle part of the paper which is black and horizontal, when you copy a book.
 - **Border Erase**. Erases the certain amount of the edge of the printout.
- Press **OK** to begin copying.
- Press **Stop/Clear** to return to ready mode.

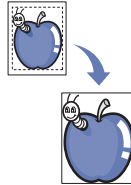

Gray enhance copying

When you copy the original in gray scale, use this feature for the better quality of copy-output. This feature is only for the copy in gray scale.

- Press **Copy**.
- Load originals face up into the DADF, or place a single original face down on the scanner glass.
For details about loading an original, see page 32.
- Press **Menu** until **Copy Feature** appears on the bottom line of the display and press **OK**.
- Press **OK** when **Gray Enhance** appears.
- Press the left/right arrow to select **On**.
- Press **OK** to begin copying.
- Press **Stop/Clear** to return to ready mode.

PRINTING ON BOTH SIDES OF PAPER

By using the **Duplex** button on your machine, you can set the machine to print documents on both sides of paper.

- Press **Copy**.
- Press **Duplex**.
- Press the left/right arrow until the binding option you want appears.
 - **Off**: Copys in Normal mode.
 - **1->2Side Short**: Copys pages to be read by flipping like a note pad.

 When **Original Type** is set to **Photo**, the MFX-C2500 can use this function on both the DADF and the Scanner glass.

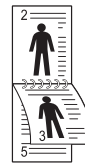

- **1->2Side Long**: Copys pages to be read like a book.

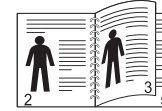

When **Original Type** is set to **Photo** the MFX-C2500 can use this function on both the DADF and the Scanner glass.



- **2->1Side**: Copys both sides of the originals and prints each of one on a separate sheet.



- **2->2Side**: Copys both sides of the original and prints on both sides of the paper. This function produces exactly the same print out from the originals.

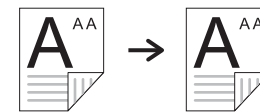

- **2->1Side ROT2**: Copys both sides of the original and prints each one on a separate sheet, but the information on the back side of the printout is rotated 180°.



- Press **OK** to save your selection.
If the mode is enabled, the **Duplex** button is backlit.

SETTING COPY TIMEOUT

You can set the time the machine waits before it restores the default copy settings, if you do not start copying after changing them on the control panel.

- Press **Menu** until **System Setup** appears on the bottom line of the display and press **OK**.
- Press **OK** when **Machine Setup** appears.
- Press the left/right arrow until **Timeout** appears and press **OK**.
- Press the left/right arrow until the time setting you want appears.
Selecting **Off** means that the machine does not restore the default settings until you press **Black Start** or **Color Start** to begin copying, or **Stop/Clear** to cancel.
- Press **OK** to save your selection.
- Press **Stop/Clear** to return to ready mode.

scanning

Scanning with your machine lets you turn pictures and text into digital files that can be stored on your computer.

This chapter includes:

- Scanning basics
- Scanning from the control panel
- Scanning by a network connection
- Changing the settings for each scan job

 The maximum resolution that can be achieved depends upon various factors, including computer speed, available disk space, memory, the size of the image being scanned, and bit depth settings. Thus, depending on your system and what you are scanning, you may not be able to scan at certain resolutions, especially using enhanced resolution.

SCANNING BASICS

You can scan the originals with your machine via a USB cable or the network.

- **Scan Manager:** You just walk to the machine with the originals and scan them from the control panel then, the scanned data will be stored in the connected computers **My Documents** folder. When the setup installation is completed, then you have installed the **Scan Manager** on your computer already. This feature can be used via the local connection or the network connection. See next section.
- **TWAIN:** TWAIN is the one of preset imaging applications. Scanning an image launches the selected application, enabling you to control the scanning process. See the Software section. This feature can be used via the local connection or the network connection. See *Software section*.
- **SmarThru Office :** This feature is the accompanying software for your machine. You can use this program to scan images or documents, and this feature can be used via the local connection or the network connection. See *Software section*.
- **WIA:** WIA stands for Windows Images Acquisition. To use this feature your computer must be connected directly with the machine via a USB cable. See *Software section*.
- **Email:** You can send the scanned image as an attachment to an email. See page 45.
- **FTP:** You can scan an image and upload it to an FTP server. See page 46.
- **SMB:** You can scan an image and send it to a shared folder on an SMB server. See page 46.

- Changing the default scan settings
- Setting up Address Book
- Scan on both sides of paper

SCANNING FROM THE CONTROL PANEL

Your machine offers you to scan from the control panel and easily send the scanned document to connected computer's **My Documents** folder. In order to use this function, your machine and computer must be connect by USB cable or by network.

Also, with the offered **Scan Manager** program, scanned documents can be opened with the program you have setup previously. Such as Microsoft Paint, Email, SmarThru Office, OCR can be added to application program. See "Setting scan information in Scan Manager." on page 43.

Scanned images can be saved as BMP, JPEG, TIFF, PDF files.

Setting scan information in Scan Manager.

You can find out about **Scan Manager** program information and installed scan driver's condition. Also, you can change scan settings and add or delete the folders where scanned documents to computer are save in **Scan Manager** program.

 **Scan Manager** program can only be used in the Window and Macintosh system. If you use the Macintosh, See *Software section*.



1. Press **Start>Control Panel> Scan Manager**.
Scan Manager Administration appears.

 You can open **Scan Manager** by pressing the **Smart Panel** icon's right in the window task bar.

2. Select the appropriate machine from the **Scan Manager**.
3. Press **Scan Property**.
4. **Set Scan Button** allows you to change the saving destination and scan settings, add or delete application program and format files.
You can change the scanning machine by using **Change Port**. (Local or Network)
5. Press **OK** after setting is done.

Scanning to application programs

1. Make sure that your machine and computer are turned on and properly connected to each other.
2. Load originals face up into the DADF, or place a single original face down on the scanner glass.
For details about loading an original, see page 32.
3. Press **Scan/Email**.
Ready to Scan appears on the top line of the display.
4. Press the left/right arrow until **Scan to PC** appears on the bottom line of the display and press **OK**.
5. Press the left/right arrow until the option you want appears and press **OK**.

6. Depending on the port connection, different messages appear. Check the following messages and move on to the next step.
 - **Scan Destination:** Connected by USB. Move to step 7.
 - **ID:** Connected by Network and user is registered. Move to step 6.
 - **◀Local PC▶:** Choosing USB or Network to scan. If connected by USB, move to step 5. If connected by Network, move to step 6.
 - **Not Available:** Neither connected by USB nor Network. Check the port connection.
7. Press the left/right arrow until the port you want appears on the display.
8. Enter the registered user ID and PIN and click **OK**.
 -  • ID is the same ID as the registered ID for **Scan Manager**.
 - PIN is the 4 digit number registered for **Scan Manager**.
9. From **Scan Destination**, press the left/right arrow until the application program you want appears, then press **OK**. Default setting is **My Documents**.
 -  To add or delete the folder where the scanned file is saved, add or delete the application program in **Scan Manager>Set Scan Button**.
10. To scan from the default setting, press **Color Start** or **Black Start**. Press the left/right button until the setting you want appears then press **OK**.
11. Scanning begins.
 -  • Scanned image is saved in computer's **My Documents> My Pictures>Samsung** folder.
 - You can use Tawin driver to scan quickly in **Scan Manager** program.
 - You can also scan by pressing Window's **Start>Control Panel> Scan Manager>Quick Scan**.

SCANNING BY A NETWORK CONNECTION

If you have connected your machine to a network and set up the network parameters correctly, you can scan and send images over the network.

Preparing for network scanning

Before using your machine's network scanning features, you need to configure the following settings, depending on your scan destination:

- Register as an authorized user for scanning to email, FTP, or SMB
- Set up the SMTP server for scanning to email
- Set up the FTP servers for scanning to FTP
- Set up the SMB servers for scanning to SMB

User authentication for network scanning

To send an email, FTP, SMB or Network, you must register authorized local or network users using SyncThru™ Web Service.

- If user authentication has been activated, only authorized local users or on the DB server (SMB, LDAP, Kerberos) can send scanned data to the network (email, FTP, SMB, Network).
- For network scanning using the authentication feature, you must register the network or local authentication configuration using the SyncThru™ Web Service.
- User authentication has 3 options: none (Default), network authentication, and local authentication.

Registering local authorized users

1. Enter your machine's IP address as the URL in a browser and click **Go** to access the web site of your machine.
2. Click **Machine Settings**.
3. Select **Local Authentication** on the **General Setup of the User Authentication** web page.
4. Click **Add**.
5. Select an index number corresponding to the location for storing the entry, from 1 to 50.
6. Enter your name, auth ID, password, e-mail address and phone number.
You need to enter the registered user ID and password in the machine when you start scanning to email from the control panel.
7. Click **Apply**.

Register authorized network users

1. Enter your machine's IP address as the URL in a browser and click **Go** to access the web site of your machine.
2. Click **Machine Settings**.
3. Select **Network Authentication** on the **General Setup of User Authentication** web page.
4. Click **Apply** and **OK**.
5. Select the **Authentication Type** that you prefer.
6. Configure the values for each feature, as follows.
7. Click **Apply**.

Network user authenticated by Kerberos

1. Enter the realm used for **Kerberos** login.
2. Select **IP Address** or **Host Name**.
3. Enter the IP address in dotted decimal notation or as a host name.
4. Enter the server port number, from 1 to 65535.
The default port number is 88.
5. You can add a backup domain as a previous step.
6. Click **Apply**.

Network user authorized by SMB

1. Enter the domain that is used for **SMB** login.
2. Select **IP Address** or **Host Name**.
3. Enter the IP address in dotted decimal notation or as a host name.
4. Enter the server port number, from 1 to 65535.
The default port number is 139.
5. You can add a backup domain as a previous step.
6. Click **Apply**.

 User can add up to 6 alternate domains.

Network authorized user by LDAP

1. Enter your machine's IP address as the URL in a browser and click **Go** to access the web site of your machine.
2. Click **Machine Settings** and **LDAP Server Setup**.
3. Select **IP Address** or **Host Name**.
4. Enter the IP address in dotted decimal notation or as a host name.
5. Enter the server port number, from 1 to 65535.
The default port number is 389.
6. Enter **Search Root Directory**, the top search level of the LDAP directory tree.
7. Select **Authentication method**. Two options for LDAP server login.
Anonymous:This is used to bind with null password and login ID

(Password and login ID are grayed out in SWS).

Simple: This is used to bind with the login ID and password in SWS.

8. Check the box next to **Append Root to Base DN**.
9. Select **Match User's Login ID to the following LDAP attribute** (options are CN, UID, or UserPrincipalName).
10. Enter your login name, password, maximum number of search results and search timeout.

 **LDAP Referral:** LDAP client will search referral server if the LDAP server has no data to reply to query and if the LDAP server has a referral server.

11. Select **Serach Name Order** that you desire.
12. Check the box next to **"From:" Field Security Options**.

 This option is only provided if you have selected the Network authentication option in the user authentication setting. You may check this option if you want to search for information in a default email address group.

13. Click **Apply**.

Setting up an e-mail account

To scan and send an image as an email attachment, you need to set up network parameters using SyncThru™ Web Service.

1. Enter your machine's IP address as the URL in a browser and click **Go** to access the web site of your machine.
2. Click **Machine Settings** and **E-mail Setup**.
3. Select **IP Address** or **Host Name**.
4. Enter the IP address in dotted decimal notation or as a host name.
5. Enter the server port number, from 1 to 65535. The default port number is 25.
6. Check the box next to **SMTP Requires Authentication** to require authentication.
7. Enter the SMTP server login name and password.
8. Click **Apply**.

 If the authentication method of SMTP server is POP3beforeSMTP, check the box next to **SMTP Requires POP3 Before SMTP Authentication**.

- a. Enter the IP address in dotted decimal notation or as a host name.
- b. Enter the server port number, from 1 to 65535. The default port number is 25.

Setting up an FTP server

To use an FTP server, you need to set up parameters to access the FTP servers using SyncThru™ Web Service.

1. Enter your machine's IP address as the URL in a browser and click **Go** to access the web site of your machine.
2. Click **Machine Settings** and **FTP Setup**.
3. Click **Server List**.
4. Click **Add**.
5. Select the index number, from 1 to 20.
6. Enter a name in **Alias for the Setup** for the corresponding Server List entry. This name will be displayed on your machine.
7. Select **IP Address** or **Host Name**.
8. Enter the server address in dotted decimal notation or a host name.
9. Enter the server port number, from 1 to 65535. The default port number is 21.

10. Check the box next to **Anonymous** if you want the FTP server to permit access to unauthorized persons. It is unchecked by default.
11. Enter the login name and password.
12. Enter the **Scan File Folder** under FTP directory for saving the scanned image.
13. Click **Apply**.

Setting up an SMB server

To use an SMB server, you need to set up parameters for access to SMB servers using SyncThru™ Web Service.

1. Enter your machine's IP address as the URL in a browser and click **Go** to access the web site of your machine.
2. Click **Machine Settings** and **SMB Setup**.
3. Click **Server List**.
4. Click **Add**.
5. Select the index number, from 1 to 20.
6. Enter a name in **Alias for the Setup** for the corresponding Server List entry. This name will be displayed on your machine.
7. Select **IP Address** or **Host Name**.
8. Enter the server address in dotted decimal notation or a host name.
9. Enter the server port number, from 1 to 65535. The default port number is 139.
10. Enter the **Share name** of the server.
11. Check the box next to **Anonymous** if you want to permit unauthorized persons to access the SMB server. This box is unchecked by default.
12. Enter the login name and password.
13. Enter the domain name of the SMB server.
14. Enter the **Scan File Folder** under shared folder for storing the scanned image.
15. Click **Apply**.

Scanning to Email

You can scan and send an image as an email attachment. You first need to set up your email account in SyncThru™ Web Service. See page 45.

Before scanning, you can set the scan options for your scan job. See page 46.

1. Make sure that your machine is connected to a network.
2. Load originals face up into the DADF, or place a single original face down on the scanner glass. For details about loading an original, see page 32.
3. Press **Scan/Email**.
4. Press the left/right arrow until **Scan to Email** appears on the bottom line of the display and press **OK**.
5. Enter the recipient's email address and press **OK**. If you have set up Address Book, you can use a speed button or a speed email or group email number to retrieve an address from memory. See page 47.
6. To enter additional addresses, press **OK** when **Yes** appears and repeat step 5. To continue to the next step, press the left/right arrow to select **No** and press **OK**.
7. If the display asks if you want to send the email to your account, press the left/right arrow to select **Yes** or **No** and press **OK**.

 This prompt does not appear if you have activated the Send To Self option in the email account setup.

8. Enter an email subject and press **OK**.

9. Press the left/right arrow until the file format you want appears and press **OK** or **Start**.
The machine begins scanning and then sends the email.
10. If the machine asks if you want to log off your account, press the left/right arrow to select **Yes** or **No** and press **OK**.
11. Press **Stop/Clear** to return to ready mode.

Scanning to an FTP server

You can scan an image and then upload it to an FTP server. You need to set up parameters for access to FTP servers from **SyncThru™ Web Service**. See page 45.

Before scanning, you can set the scan options for your scan job. See page 46.

1. Make sure that your machine is connected to a network.
2. Load originals face up into the DADF or place a single original on the scanner glass.
For details about loading an original, see page 32.
3. Press **Scan/Email**.
4. Press the left/right arrow until **Scan to FTP** appears on the bottom line of the display and press **OK**.
5. Enter the user ID and press **OK**.
6. Enter the password and press **OK**.
7. Press the left/right arrow until the FTP server you want appears and press **OK** or **Start**.
8. Press the left/right arrow until the file type you want appears and press **OK** or **Start**.
The machine begins scanning and then sends the file to the specified server.

Scanning to an SMB server

You can scan an image and then send it to an SMB server. You need to set up parameters for access to SMB servers from **SyncThru™ Web Service**. See page 45.

Before scanning, you can set the scan options for your scan job. See page 46.

1. Make sure that your machine is connected to a network.
2. Load originals face up into the DADF or place a single original on the scanner glass.
For details about loading an original, see page 32.
3. Press **Scan/Email**.
4. Press the left/right arrow until **Scan to SMB** appears on the bottom line of the display and press **OK**.
5. Enter the user ID and press **OK**.
6. Enter the password and press **OK**.
7. Press the left/right arrow until the SMB server you want appears and press **OK** or **Start**.
8. Press the left/right arrow until the file format you want appears and press **OK** or **Start**.
The machine begins scanning and then sends the file to the specified server.

CHANGING THE SETTINGS FOR EACH SCAN JOB

Your machine provides you with the following setting options to allow you to customize your scan jobs.

- **Scan Size:** Sets the image size.
- **Original Type:** Sets the original document's type.
- **Resolution:** Sets the image resolution.
- **Scan Color:** Sets the color mode.
- **Scan Format:** Sets the file format in which the image is to be saved. If you select TIFF or PDF, you can select to scan multiple pages. Depending on the selected scan type, this option may not appear.

To customize the settings before starting a scan job:

1. Press **Scan/Email**.
2. Press **Menu** until **Scan Feature** appears on the bottom line of the display and press **OK**.
3. Press the left/right arrow until the scan type you want appears and press **OK**.
4. Press the left/right arrow until the scan setting option you want appears and press **OK**.
5. Press the left/right arrow until the desired status appears and press **OK**.
6. Repeat steps 4 and 5 to set other setting options.
7. When you have finished, press **Stop/Clear** to return to ready mode.

CHANGING THE DEFAULT SCAN SETTINGS

To avoid having to customize the scan settings for each job, you can set up default scan settings for each scan type.

1. Press **Scan/Email**.
2. Press **Menu** until **Scan Setup** appears on the bottom line of the display and press **OK**.
3. Press **OK** when **Change Default** appears.
4. Press the left/right arrow until the scan type you want appears and press **OK**.
5. Press the left/right arrow until the scan setting option you want appears and press **OK**.
6. Press the left/right arrow until the desired status appears and press **OK**.
7. Repeat steps 5 and 6 to change other settings.
8. To change the default settings for other scan types, press **Back** and repeat from step 4.
9. Press **Stop/Clear** to return to ready mode.

PRINTING SCAN CONFIRMATION REPORT AUTOMATICALLY

You can set your machine to print a confirmation report showing whether a transmission was successful, how many pages were sent, and more. The report shows the job of scanning and sending it via SMB and FTP.

1. Press **Scan/Email**.
2. Press **Menu** until **Scan Setup** appears on the bottom line of the display and press **OK**.
3. Press **OK** when **Send Report** appears.
4. Press the left/right arrow until the scan setting option you want appears and press **OK**.
 - **On-Error:** Only in case of error occurrence, the machine prints the report.
 - **On:** The report is printed whether a job successfully completed or failed.
 - **Off:** No report is printed after completing a job.
5. Press **Stop/Clear** to return to ready mode.

SETTING UP ADDRESS BOOK

You can set up **Address Book** with the email addresses you use frequently via **SyncThru™ Web Service** and then easily and quickly enter email addresses by entering the location numbers assigned to them in **Address Book**.

Registering speed email numbers

1. Enter your machine's IP address as the URL in a browser and click **Go** to access the web site of your machine.
2. Click **Machine Settings** and **E-mail Setup**.
3. Click **Individual Address Book** and **Add**.
4. Select a location number and enter the user name and e-mail address you want.
5. Click **Apply**.



You can also click **Import** and obtain your address book from your computer.

Configuring group email numbers

Enter your machine's IP address as the URL in a browser and click **Go** to access the web site of your machine.

1. Click **Machine Settings** and **E-mail Setup**.
2. Click **Group Address Book** and **Add**.
3. Select a group number and enter the group name you want.
4. Select speed email numbers that will be included in the group.
5. Click **Apply**.

Retrieving global email addresses from the LDAP server

You can use not only local addresses stored in your machine's memory but also ones in the LDAP server. To use the global addresses, configure the LDAP server first via **SyncThru™ Web Service** as following:

1. Enter your machine's IP address as the URL in a browser and click **Go** to access the web site of your machine.
2. Click **Machine Settings**, **LDAP Server Setup**.
3. Select **IP Address** or **Host Name**.
4. Enter the IP address in dotted decimal notation or as a host name.
5. Enter the server port number, from 1 to 65535.
The default port number is 389.
6. Enter **Search Root Directory**. The top search level of the LDAP directory tree
7. Select **Authentication method**. Method of LDAP server login.
Anonymous: This is used to bind with NULL password and login ID (Password and login ID are grayed in SWS).
Simple: This is used to bind with the login ID and password in SWS.
8. Put a check mark of **Append Root to Base DN** for adding **Base DN** to login name.
9. Enter your login name, password, maximum number of search results and search timeout.



LDAP Referral: LDAP client will search referral server in case LDAP server has no data to reply of query and LDAP server has any referral server.

10. Select **Search Name Order** that you want.
11. Put a check mark of **"From:" Field Security Options**.
12. Click **Add**.

Using Address Book entries

To retrieve an email address, use the following ways:

Speed email numbers

When you are prompted to enter a destination address while sending an email, enter the speed email number at which you stored the address you want.

- For a one-digit speed email location, press and hold the corresponding digit button from the number keypad.
- For a two- or three-digit speed email location, press the first digit button(s) and then hold down the last digit button.

You can also press the speed buttons at which you stored the address you want.

You can also search through memory for an entry by pressing **Address Book**. See page 47.

Group email numbers

To use a group email entry, you need to search for and select it from memory.

When you are prompted to enter a destination address while sending an email, press **Address Book**. See page 47

Global email addresses

To use a global email addresses in the LDAP server, you need to search for and select it from memory.

When you are prompted to enter a destination address while sending an email, press **Address Book**. See page 47.

Searching Address Book for an entry

There are two ways to search for an address in memory. You can either scan from A to Z sequentially or search by entering the first letters of the name associated with the address.

Searching sequentially through memory

1. If necessary, press **Scan/Email**.
2. Press **Address Book** until **Search & Send** appears on the bottom line of the display and press **OK**.
3. Press the left/right arrow until the number category you want appears and press **OK**.
4. Press **OK** when **All** appears.
5. Press the left/right arrow until the name and address you want appears. You can search upwards or downwards through the entire memory in alphabetical order.

Searching with a particular first letter

1. If necessary, press **Scan/Email**.
2. Press **Address Book** until **Search & Send** appears on the bottom line of the display and press **OK**.
3. Press the left/right arrow until the number category you want appears and press **OK**.
4. Press the left/right arrow until **ID** appears and press **OK**.
5. Enter the first few letters of the name you want and press **OK**.
6. Press the left/right arrow until the name you want appears and press **OK**.

Printing Address Book

You can check your **Address Book** settings by printing a list.

1. Press **Address Book** until **Print** appears on the bottom line of the display.
2. Press **OK**.
A list showing your speed button settings, and the speed/group email entries print out.

SCAN ON BOTH SIDES OF PAPER

By using the **Duplex** button on your machine, you can set the machine to scan on both sides of paper.

1. Press **Duplex**.
2. Press the left/right arrow until the binding option you want appears.
 - **Off**: Scans in Normal mode.
 - **2 Side**: Scans both sides of the original.
 - **2 ->1Side ROT2**: Scans both sides of the original and prints each one on a separate sheet, but the information on the back side of the printout is rotated 180°.
3. Press **OK** to save your selection.
If the mode is enabled, the **Duplex** button is backlit.

basic printing

This chapter explains common printing tasks.

This chapter includes:

- Printing a document
- Canceling a print job

PRINTING A DOCUMENT

Your machine allows you to print from various Windows, Macintosh, or Linux applications. The exact steps for printing a document may vary depending on the application you use.

For details about printing, see the *Software section*.

CANCELING A PRINT JOB

If the print job is waiting in a print queue or print spooler, such as the printer group in Windows, delete the job as follows:

1. Click the Windows **Start** menu.
2. For Windows 2000, select **Settings** and then **Printers**.
For Windows XP/2003, select **Printers and Faxes**.
For Windows Vista, select **Control Panel > Hardware and Sound > Printers**.
3. Double-click the CLX-6200 Series or CLX-6240 Series icon.
(Or CLX-6200 Series PS or CLX-6240 Series PS)
4. From the **Document** menu, select **Cancel**.



You can also access this window by simply double-clicking the printer icon at the bottom right corner of the Windows desktop.

You can also cancel the current job by pressing **Stop/Clear** on the control panel.

This chapter includes:

- Sending a fax
- Receiving a fax

 You may experience restrictions on color fax transmission, slower fax transmission, poor fax quality and communication failures when faxing over VoIP network. Contact your local network administrator or Internet Service Provider for more details.

SENDING A FAX

Setting the fax header

In some countries, you are required by law to indicate your fax number on any fax you send. The Machine ID, containing your telephone number and name or company name, will be printed at the top of each page sent from your machine.

1. Press **Menu** until **System Setup** appears on the bottom line of the display and press **OK**.
2. Press **OK** when **Machine Setup** appears.
3. Press **OK** when **Machine ID** appears.
4. Enter your name or the company name using the number keypad. You can enter alphanumeric characters using the number keypad, and include special symbols by pressing the **0** button. For details on how to enter alphanumeric characters, see page 29.
5. Press **OK** to save the ID.
6. Press the left/right arrow until **Machine Fax No.** appears and press **OK**.
7. Enter your fax number using the number keypad and press **OK**.
8. Press **Stop/Clear** to return to ready mode.

Adjusting the document settings

Before starting a fax, change the following settings according to your original's status to get the best quality.

Resolution

The default document settings produce good results when using typical text-based originals. However, if you send originals that are of poor quality, or contain photographs, you can adjust the resolution to produce a higher quality Fax.

1. Press **Resolution**.
2. Press **Resolution** or the left/right arrow until the option you want appears.
3. Press **OK** to save your selection.

- Other ways to fax
- Fax setup

Recommended resolution settings for different original document types are described in the table below:

MODE	RECOMMENDED FOR:
Standard	Originals with normal sized characters.
Fine	Originals containing small characters or thin lines or originals printed using a dot-matrix printer.
Super Fine	Originals containing extremely fine detail. Super Fine mode is enabled only if the machine with which you are communicating also supports the Super Fine resolution. <ul style="list-style-type: none">  For memory transmission, Super Fine mode is not available. The resolution setting is automatically changed to Fine. When your machine is set to Super Fine resolution and the fax machine with which you are communicating does not support Super Fine resolution, the machine transmits using the highest resolution mode supported by the other fax machine.
Photo Fax	Originals containing shades of gray or photographs.

 The resolution setting is applied to the current fax job. To change the default setting, see page 56.

Darkness

You can select the default contrast mode to fax your originals lighter or darker.

1. Press **Fax**.
2. Press **Menu**, and then **OK** when **Fax Feature** appears on the bottom line of the display.
3. Press **OK** when **Darkness** appears.
4. Press the left/right arrow until the option you want appears and press **OK**.
5. Press **Stop/Clear** to return to ready mode.

 The darkness setting is applied to the current fax job. To change the default setting, see page 56.

Sending a fax automatically

1. Press **Fax**.
2. Load originals face up into the DADF, or place a single original face down on the scanner glass.
For details about loading an original, see page 32.
Ready to Fax appears on the top line of the display.
3. Adjust the resolution and the darkness to suit your fax needs.
4. Enter the receiving fax machine's number.
You can use speed buttons, speed dial numbers, or group dial numbers.
For details about storing and searching for a number, see page 56.
5. Press **Color Start** or **Black Start**.
6. If an original is placed on the scanner glass, select **Yes** to add another page. Load another original and press **OK**.
7. When you have finished, select **No** at the **Another Page?** prompt.
After the number is dialed, the machine begins sending the fax when the receiving fax machine answers.

 When you want to cancel a fax job, press **Stop/Clear** at any time while sending.

Sending a fax manually

1. Press **Fax**.
2. Load originals face up into the DADF, or place a single original face down on the scanner glass.
For details about loading an original, see page 32.
3. Adjust the resolution and the darkness to suit your fax needs. See page 50.
4. Press **On Hook Dial**. You hear a dial tone.
5. Enter the receiving fax machine's number.
You can use speed buttons, speed dial numbers, or group dial numbers.
For details about storing and searching for a number, see page 56.
6. Press **Color Start** or **Black Start** when you hear a high-pitched fax signal from the remote fax machine.

 When you want to cancel a fax job, press **Stop/Clear** at any time while sending.

Confirming a transmission

When the last page of your original has been sent successfully, the machine beeps and returns to ready mode.

When something goes wrong while sending your fax, an error message appears on the display. For a list of error messages and their meanings, see page 77. If you receive an error message, press **Stop/Clear** to clear the message and try to send the fax again.

You can set your machine to print a confirmation report automatically each time sending a fax is completed. For further details, see page 55.

Automatic redialing

When the number you have dialed is busy or there is no answer when you send a fax, the machine automatically redials the number every three minutes, up to seven times according to the factory default settings.

When the display shows **Retry Redial?**, press **OK** to redial the number without waiting. To cancel the automatic redialing, press **Stop/Clear**.

To change the time interval between redials and the number of redial attempts. See page 55.

Redialing the last number

To redial the number you called last:

1. Press **Redial/Pause**.
2. When an original is loaded in the DADF, the machine automatically begins to send.
If an original is placed on the scanner glass, select **Yes** to add another page. Load another original and press **OK**. When you have finished, select **No** at the **Another Page?** prompt.

Sending faxes on both sides of paper

You can set the machine to send faxes on both sides of paper.

1. Press **Fax**.
2. Press **Duplex**.
3. Press the left/right arrow until the binding option you want appears.
 - **Off**: Send faxes in Normal mode.
 - **2 Side**: Send faxes on both sides of the original.
 - **2 ->1Side ROT2**: Send faxes on both sides of the original and prints each one on a separate sheet, but the information on the back side of the printout is rotated 180°.
4. Press **OK** to save your selection.
If the mode is enabled, the **Duplex** button is backlit.

RECEIVING A FAX

Selecting the paper tray

After loading the print media for fax output, you have to select the paper tray you will use for the fax reception.

1. Press **Menu** until **System Setup** appears on the bottom line of the display and press **OK**.
2. Press the left/right arrow until **Paper Setup** appears and press **OK**.
3. Press the left/right arrow until **Paper Source** appears and press **OK**.
4. Press the left/right arrow until **Fax Tray** appears and press **OK**.
5. Press the left/right arrow until the paper tray you want appears and press **OK**.
6. Press **Stop/Clear** to return to ready mode.

Changing receiving modes

1. Press **Fax**.
2. Press **Menu** until **Fax Setup** appears on the bottom line of the display and press **OK**.
3. Press the left/right arrow until **Receiving** appears and press **OK**.
4. Press **OK** when **Receive Mode** appears.
5. Press the left/right arrow until the fax reception mode you want appears.
 - In **Fax** mode, the machine answers an incoming fax call and immediately goes into the fax reception mode.
 - In **Tel** mode, you can receive a fax by pressing **On Hook Dial** and then **Color Start** or **Black Start**. You can also pick up the handset of the extension phone and then press the remote receive code. See page 52.
 - In **Ans/Fax** mode, an answering machine attached to your machine answers an incoming call, and the caller can leave a message on the answering machine. If the fax machine senses a fax tone on the line, the machine automatically switches to **Fax** mode to receive the fax. See page 52.
 - In **DRPD** mode, you can receive a call using the Distinctive Ring

Pattern Detection (DRPD) feature. Distinctive Ring is a telephone company service which enables an user to use a single telephone line to answer several different telephone numbers. For further details, see page 52.

6. Press **OK** to save your selection.

7. Press **Stop/Clear** to return to ready mode.



- When the memory is full, the printer can no longer receive any incoming fax. Secure free memory to resume by removing data stored in the memory.
- To use the **Ans/Fax** mode, attach an answering machine to the EXT socket on the back of your machine.
- If you do not want other people to view your received documents, you can use secure receiving mode. In this mode, all of the received faxes are stored in memory. For further details, see page 52.

Receiving automatically in Fax mode

Your machine is preset to **Fax** mode at the factory. When you receive a fax, the machine answers the call on a specified number of rings and automatically receives the fax.

To change the number of rings, see page 55.

Receiving manually in Tel mode

You can receive a fax call by pressing **On Hook Dial** and then pressing **Black Start** or **Color Start** when you hear a fax tone from the remote machine.

The machine begins receiving a fax and returns to ready mode when the reception is completed.

Receiving manually using an extension telephone

This feature works best when you are using an extension telephone connected to the EXT socket on the back of your machine. You can receive a fax from someone you are talking to on the extension telephone without going to the fax machine.

When you receive a call on the extension phone and hear fax tones, press the keys ***9*** on the extension phone. The machine receives the fax.

Press the buttons slowly in sequence. If you still hear the fax tone from the remote machine, try pressing ***9*** once again.

9 is the remote receive code preset at the factory. The first and the last asterisks are fixed, but you can change the middle number to whatever you wish. For details about changing the code, see page 55.

Receiving automatically in Ans/Fax mode

To use this mode, you must attach an answering machine to the EXT socket on the back of your machine.

If the caller leaves a message, the answering machine stores the message as it would normally. If your machine detects a fax tone on the line, it automatically starts to receive the fax.



- If you have set your machine to **Ans/Fax** mode and your answering machine is switched off, or no answering machine is connected to EXT socket, your machine automatically goes into **Fax** mode after a predefined number of rings.
- If your answering machine has a user-selectable ring counter, set the machine to answer incoming calls within 1 ring.
- If you are in **Tel** mode (manual reception) when the answering machine is connected to your machine, you must switch off the answering machine, or the outgoing message from the answering machine will interrupt your phone conversation.

Receiving faxes using DRPD mode

Distinctive Ring is a telephone company service which enables an user to use a single telephone line to answer several different telephone numbers. The particular number someone uses to call you is identified by different ringing patterns, which consist of various combinations of long and short ringing sounds. This feature is often used by answering services who answer telephones for many different clients and need to know which number someone is calling in on to properly answer the phone.

Using the Distinctive Ring Pattern Detection (DRPD) feature, your fax machine can learn the ring pattern you designate to be answered by the fax machine. Unless you change it, this ringing pattern will continue to be recognized and answered as a fax call, and all other ringing patterns will be forwarded to the extension telephone or answering machine plugged into the EXT socket. You can easily suspend or change DRPD at any time.

Before using the DRPD option, Distinctive Ring service must be installed on your telephone line by the telephone company. To set up DRPD, you will need another telephone line at your location, or someone available to dial your fax number from outside.

To set up the **DRPD** mode:

1. Press **Fax**.
2. Press **Menu** until **Fax Setup** appears on the bottom line of the display and press **OK**.
3. Press the left/right arrow until **Receiving** appears and press **OK**.
4. Press the left/right arrow until **DRPD Mode** appears and press **OK**. **Waiting Ring** appears on the display.
5. Call your fax number from another telephone. It is not necessary to place the call from a fax machine.
6. When your machine begins to ring, do not answer the call. The machine requires several rings to learn the pattern.
When the machine completes learning, the display shows **Completed DRPD Setup**. If the DRPD setup fails, **Error DRPD Ring** appears. Press **OK** when **DRPD Mode** appears and start over from step 4.
7. Press **Stop/Clear** to return to ready mode.



- DRPD must be set up again if you re-assign your fax number, or connect the machine to another telephone line.
- After DRPD has been set up, call your fax number again to verify that the machine answers with a fax tone. Then have a call placed to a different number assigned to that same line to be sure the call is forwarded to the extension telephone or answering machine plugged into the EXT socket.

Receiving in secure receiving mode

You may need to prevent your received faxes from being accessed by unauthorized people. You can turn on secure receiving mode to restrict printing of received faxes when the machine is unattended. In secure receiving mode, all incoming faxes go into memory. When the mode is deactivated, any stored faxes are printed.

Activating secure receiving mode

1. Press **Fax**.
2. Press **Menu** and then press **OK** when **Fax Feature** appears on the bottom line of the display.
3. Press the left/right arrow until **Secure Receive** appears and press **OK**.
4. Press the left/right arrow until **On** appears and press **OK**.
5. Enter a four-digit password you want to use and press **OK**.



- You can activate secure receiving mode without setting a password, but cannot protect your faxes.

6. Re-enter the password to confirm it and press **OK**.
7. Press **Stop/Clear** to return to ready mode.

When a fax is received in secure receiving mode, your machine stores it in memory and shows **Secure Receive** to let you know that there is a fax received.

Printing received faxes

1. Access the **Secure Receive** menu by following steps 1 through 3 in "Activating secure receiving mode."
2. Press the left/right arrow until **Print** appears and press **OK**.
3. Enter the four-digit password and press **OK**.
The machine prints all of the faxes stored in memory.

Deactivating secure receiving mode

1. Access the **Secure Receive** menu by following steps 1 through 3 in "Activating secure receiving mode."
2. Press the left/right arrow until **Off** appears and press **OK**.
3. Enter the four-digit password and press **OK**.
The mode is deactivated and the machine prints all faxes stored in memory.
4. Press **Stop/Clear** to return to ready mode.

Receiving faxes in memory

Since your machine is a multi-tasking device, it can receive faxes while you are making copies or printing. If you receive a fax while you are copying or printing, your machine stores incoming faxes in its memory. Then, as soon as you finish copying or printing, the machine automatically prints the fax.

Also, your machine receives faxes and stores them in its memory when there is no paper in the tray or no toner in the installed toner cartridge.

OTHER WAYS TO FAX

Sending a fax to multiple destinations

You can use the Multiple Send feature, which allows you to send a fax to multiple locations. Originals are automatically stored in memory and sent to a remote station. After transmission, the originals are automatically erased from memory. You cannot send a color fax using this feature.



1. Press **Fax**.
2. Load originals face up into the DADF, or place a single original face down on the scanner glass.
For details about loading an original, see page 32.
3. Adjust the document resolution and darkness to suit your fax needs. See page 50.
4. Press **Menu** until **Fax Feature** appears on the bottom line of the display and press **OK**.
5. Press the left/right arrow until **Multi Send** appears and press **OK**.
6. Enter the number of the first receiving fax machine and press **OK**.
You can use speed buttons, speed dial numbers. You can enter Group Dial Number using **Address Book** Button. For details, see page 56.
7. Enter the second fax number and press **OK**.
The display asks you to enter another fax number to send the document.
8. To enter more fax numbers, press **OK** when **Yes** appears and repeat steps 6 and 7. You can add up to 10 destinations.

 Once you entered a group dial number, you cannot enter another group dial numbers anymore.

9. When you have finished entering fax numbers, press the left/right arrow to select **No** at the **Another No.?** prompt and press **OK**.
The original is scanned into memory before transmission. The display shows memory capacity and the number of pages being stored in memory.
10. If an original is placed on the scanner glass, select **Yes** to add another pages. Load another original and press **OK**.
When you have finished, select **No** at the **Another Page?** prompt.
The machine begins sending the fax to the numbers you entered in the order in which you entered them.

Sending a delayed fax

You can set your machine to send a fax at a later time when you will not be present. You cannot send a color fax using this feature.

1. Press **Fax**.
2. Load originals face up into the DADF, or place a single original face down on the scanner glass.
For details about loading an original, see page 32.
3. Adjust the document resolution and darkness to suit your fax needs. See page 50.
4. Press **Menu** until **Fax Feature** appears on the bottom line of the display and press **OK**.
5. Press the left/right arrow until **Delay Send** appears and press **OK**.
6. Enter the number of the receiving machine using the number keypad.
You can use speed buttons, speed dial numbers. You can enter Group Dial Number using **Address Book** Button. For details, see page 56.
7. Press **OK** to confirm the number. The display asks you to enter another fax number to which to send the document.
8. To enter more fax numbers, press **OK** when **Yes** appears and repeat steps 6 and 7. You can add up to 10 destinations.
 Once you entered a group dial number, you cannot enter another group dial numbers anymore.
9. When you have finished entering fax numbers, press the left/right arrow to select **No** at the **Another No.?** prompt and press **OK**.
10. Enter the job name you want and press **OK**.
For details on how to enter alphanumeric characters, see page 29.
If you do not want to assign a name, skip this step.
11. Enter the time using the number keypad and press **OK**, or **Black Start**.
 If you set a time earlier than the current time, the fax will be sent at that time on the following day.

The original is scanned into memory before transmission. The display shows memory capacity and the number of pages being stored in memory.

12. If an original is placed on the scanner glass, select **Yes** to add another page. Load another original and press **OK**.
When you have finished, select **No** at the **Another Page?** prompt.
The machine returns to ready mode. The display reminds you that you are in ready mode and that a delayed fax is set.

Adding pages to a delayed fax

You can add pages to the delayed transmissions previously reserved in your machine's memory.

1. Load the originals to be added and adjust document settings.
2. Press **Menu** until **Fax Feature** appears on the bottom line of the display and press **OK**.
3. Press **OK** when **Add Page** appears.

4. Press the left/right arrow until the fax job you want appears and press **OK**.
The machine scans the original into memory and shows the total number of pages and the number of the added pages.

Canceling a delayed fax

1. Press **Menu** until **Fax Feature** appears on the bottom line of the display and press **OK**.
2. Press the left/right arrow until **Cancel Job** appears and press **OK**.
3. Press the left/right arrow until the fax job you want appears and press **OK**.
4. Press **OK** when **Yes** appears.
The selected fax is deleted from memory.

Sending a priority fax

Using the Priority Fax feature, a high priority fax can be sent ahead of reserved operations. The original is scanned into memory and immediately transmitted when the current operation is finished. In addition, priority transmission will interrupt a Multiple Send operation between stations (i.e., when the transmission to station A ends, before transmission to station B begins) or between redial attempts.

1. Press **Fax**.
2. Load originals face up into the DADF, or place a single original face down on the scanner glass.
For details about loading an original, see page 32.
3. Adjust the document resolution and darkness to suit your fax needs. See page 50.
4. Press **Menu** until **Fax Feature** appears on the bottom line of the display and press **OK**.
5. Press the left/right arrow until **Priority Send** appears and press **OK**.
6. Enter the number of the receiving machine.
You can use speed buttons, speed dial numbers, or group dial numbers. For details, see page 56.
7. Press **OK** to confirm the number.
8. Enter the job name you want and press **OK**.
The original is scanned into memory before transmission. The display shows memory capacity and the number of pages being stored in memory.
9. If an original is placed on the scanner glass, select **Yes** to add another page. Load another original and press **OK**.
When you have finished, select **No** at the **Another Page?** prompt.
The machine shows the number being dialed and begins sending the fax.

Forwarding faxes

You can forward your incoming and outgoing faxes to another fax machine or email address.

Forwarding sent faxes to another fax machine

You can set the machine to send copies of all outgoing faxes to a specified destination, in addition to the fax numbers you entered.

1. Press **Fax**.
2. Press **Menu** until **Fax Feature** appears on the bottom line of the display and press **OK**.
3. Press the left/right arrow until **Forward** appears and press **OK**.
4. Press **OK** when **Fax** appears.
5. Press the left/right arrow until **Send Forward** appears and press **OK**.
6. Press the left/right arrow to select **On** and press **OK**.

7. Enter the number of the fax machine to which faxes are to be sent and press **OK**.
8. Press **Stop/Clear** to return to ready mode.
Subsequent sent faxes will be forwarded to the specified fax machine.

Forwarding sent faxes to email address

You can set the machine to send copies of all outgoing faxes to a specified destination, in addition to the email address you entered.

1. Press **Fax**.
2. Press **Menu** until **Fax Feature** appears on the bottom line of the display and press **OK**.
3. Press the left/right arrow until **Forward** appears and press **OK**.
4. Press the left/right arrow until **E-mail** appears and press **OK**.
5. Press the left/right arrow until **Send Forward** appears and press **OK**.
6. Press the left/right arrow to select **On** and press **OK**.
7. Enter your email address and press **OK**.
8. Enter the email address to which faxes are to be sent and press **OK**.
9. Press **Stop/Clear** to return to ready mode.
Subsequent sent faxes will be forwarded to the specified email address.

Forwarding received faxes to another fax machine

You can set your machine to forward incoming faxes to another fax number during a specified time period. When a fax arrives at your machine, it is stored in memory. Then, the machine dials the fax number that you have specified and sends the fax.

1. Press **Fax**.
2. Press **Menu** until **Fax Feature** appears on the bottom line of the display and press **OK**.
3. Press the left/right arrow until **Forward** appears and press **OK**.
4. Press **OK** when **Fax** appears.
5. Press the left/right arrow until **Rcv. Forward** appears and press **OK**.
6. Press the left/right arrow until **Forward** appears and press **OK**.
To set the machine to print out a fax when fax forwarding has been completed, select **Forward&Print**.
7. Enter the number of the fax machine to which faxes are to be sent and press **OK**.
8. Enter the starting time and press **OK**.
9. Enter the ending time and press **OK**.
10. Press **Stop/Clear** to return to ready mode.
Subsequent received faxes will be forwarded to the specified fax machine.

Forwarding received faxes to email address

You can set your machine to forward incoming faxes to the email address you entered.

1. Press **Fax**.
2. Press **Menu** until **Fax Feature** appears on the bottom line of the display and press **OK**.
3. Press the left/right arrow until **Forward** appears and press **OK**.
4. Press the left/right arrow until **E-mail** appears and press **OK**.
5. Press the left/right arrow until **Rcv. Forward** appears and press **OK**.
6. Press the left/right arrow until **Forward** appears and press **OK**.
To set the machine to print out a fax when fax forwarding has been completed, select **Forward&Print**.
7. Enter your email address and press **OK**.
8. Enter the email address to which faxes are to be sent and press **OK**.

9. Press **Stop/Clear** to return to ready mode.
Subsequent sent faxes will be forwarded to the specified email address.

FAX SETUP

Changing the fax setup options

Your machine provides you with various user-selectable options for setting up the fax system. You can change the default settings for your preferences and needs.

To change the fax setup options:

1. Press **Fax**.
2. Press **Menu** until **Fax Setup** appears on the bottom line of the display and press **OK**.
3. Press the left/right arrow to select **Sending** or **Receiving** and press **OK**.
4. Press the left/right arrow until the menu item you want appears and press **OK**.
5. Press the left/right arrow until the desired status appears or enter the value for the option you have selected, and press **OK**.
6. If necessary, repeat steps 4 through 5.
7. Press **Stop/Clear** to return to ready mode.

Sending options

OPTION	DESCRIPTION
Redial Times	You can specify the number of redial attempts. If you enter 0 , the machine will not redial.
Redial Term	Your machine can automatically redial a remote fax machine if it was busy. You can set an interval between attempts.
Prefix Dial	You can set a prefix of up to five digits. This number dials before any automatic dial number is started. It is useful for accessing a PABX exchange.
ECM Mode	This mode helps with poor line quality and makes sure any faxes you send are sent smoothly to any other ECM-equipped fax machine. Sending a fax using ECM may take more time.
Send Report	You can set your machine to print a confirmation report showing whether a transmission was successful, how many pages were sent, and more. The available options are On , Off , and On-Error , which prints only when a transmission is not successful.
Image TCR	This function allows users to know what fax messages have been sent by showing sent messages in the transmission report. The first page of the message is turned into an image file that is printed on the transmission report so the users can see what messages have been sent. However, you can not use this function when sending fax without saving the data in the memory.

OPTION	DESCRIPTION
Dial Mode	This setting may not be available depending on your country. If you cannot reach this option, your machine does not support this feature. You can set the dial mode for your machine to either tone dialling or pulse dialling. If you have a public telephone system or a private branch exchange(PBX) system, you may need to select Pulse . Contact your local telephone company if you are not sure which dial mode to use. If you select Pulse , some phone system features might not be available. It can also take longer to dial a fax or phone number.

Receiving options

OPTION	DESCRIPTION
Receive Mode	You can select the default fax receiving mode. For details on receiving faxes in each mode, see page 51.
Ring to Answer	You can specify the number of times the machine rings before answering an incoming call.
Stamp RCV Name	This option allows the machine to automatically print the page number, and the date and time of reception at the bottom of each page of a received fax.
Rcv Start Code	This code allows you to initiate fax reception from an extension phone plugged into the EXT socket on the back of the machine. If you pick up the extension phone and hear fax tones, enter the code. It is preset to *9* at the factory.
Auto Reduction	When receiving a fax containing pages as long as or longer than the paper loaded in the paper tray, the machine can reduce the size of the original to fit the size of the paper loaded in the machine. Turn on this feature if you want to automatically reduce an incoming page. With this feature set to Off , the machine cannot reduce the original to fit onto one page. The original will be divided and printed in actual size on two or more pages.
Discard Size	When receiving a fax containing pages as long as or longer than the paper in your machine, you can set the machine to discard a specific length from the end of the received fax. The machine will print the received fax on one or more sheets of paper, minus the data that would have been on the specified discard segment. When the received fax contains pages larger than the paper in your machine, and Auto Reduction has been turned on, the machine will reduce the fax to fit on the existing paper, and nothing will be discarded.

OPTION	DESCRIPTION
Junk Fax Setup	<p>This setting may not be available depending on your country. Using this feature, the system will not accept faxes sent from remote stations whose numbers are stored in the memory as junk fax numbers. This feature is useful for blocking any unwanted faxes.</p> <p>When you turn on this feature, you can access the following options to set junk fax numbers.</p> <ul style="list-style-type: none"> • Add: Allows you to set up to 10 fax numbers. • Delete: Allows you to delete the desired junk fax number. • Delete All: Allows you to delete all junk fax numbers.
DRPD Mode	<p>This mode enables a user to use a single telephone line to answer several different telephone numbers. In this menu, you can set the machine to recognize which ring patterns to answer. For details about this feature, see page 52.</p>
Duplex Print	<ul style="list-style-type: none"> • Long Edge: Prints pages to be read like a book. • Short Edge: Prints pages to be read by flipping like a note pad. • Off: Prints received fax on one sides of a paper.

Changing the default document settings

The fax options, including resolution and darkness, can be set to the most frequently used modes. When you send a fax, the default settings are used if they are not changed by using the corresponding button and menu.

1. Press **Fax**.
2. Press **Menu** until **Fax Setup** appears on the bottom line of the display and press **OK**.
3. Press the left/right arrow until **Change Default** appears and press **OK**.
4. Press **OK** when **Resolution** appears.
5. Press the left/right arrow until the resolution you want appears and press **OK**.
6. Press the left/right arrow until **Darkness** appears and press **OK**.
7. Press the left/right arrow until the darkness you want appears and press **OK**.
8. Press **Stop/Clear** to return to ready mode.

Printing sent fax report automatically

You can set the machine to print a report with detailed information about the previous 50 communication operations, including time and dates.

1. Press **Fax**.
2. Press **Menu** until **Fax Setup** appears on the bottom line of the display and press **OK**.
3. Press the left/right arrow until **Auto Report** appears and press **OK**.
4. Press the left/right arrow until **On** appears and press **OK**.
5. Press **Stop/Clear** to return to ready mode.

Setting up Address Book

You can set up **Address Book** with the fax numbers you use most frequently. Your machine provides you with the following features for setting up **Address Book**:

- Speed buttons
- Speed/Group dial numbers

 Before beginning to store fax numbers, make sure that your machine is in Fax mode.

Speed buttons

The 15 speed buttons on the control panel lets you store frequently-used fax numbers. You will be able to enter a fax number with the touch of a button. By utilizing the **Shift** button, you can store up to 30 numbers on the speed buttons.

There are two ways to assign numbers to speed buttons. Examine the procedures below and use the appropriate way which you prefer:

Registering after pressing a speed button

1. Press **Fax**.
2. Press one of the speed buttons.
3. Press **OK** when **Yes** appears.
4. Enter the name you want and press **OK**.
For details on how to enter alphanumeric characters, see page 29.
5. Enter the fax number you want to store and press **OK**.

Registering after entering a number first

1. Press **Fax**.
2. Enter the fax number you want to store.
3. Press one of the speed buttons.
4. Press **OK** when **Yes** appears.

 If you press a speed button already assigned, the display asks if you want to overwrite. Press **OK** to confirm **Yes** and continue. To start over with another speed button, select **No**.

5. Enter the name you want and press **OK**.
For details on how to enter alphanumeric characters, see page 29.
6. Press **OK** to confirm the number.

Using speed buttons

When you are prompted to enter a fax number while sending a fax:

- To retrieve a number from speed buttons 1 to 15, press the corresponding speed button and press **OK**.
- To retrieve a number from speed buttons 16 to 30, press **Shift** and then the corresponding speed button, and press **OK**.

Speed dial numbers

You can store up to 240 frequently-used fax numbers in speed dial numbers.

Registering a speed dial number

1. Press **Fax**.
2. Press **Address Book** until **New & Edit** appears on the bottom line of the display and press **OK**.
3. Press **OK** when **Speed Dial** appears.
4. Enter a speed dial number between 0 and 239 and press **OK**.
If an entry is already stored in the number you choose, the display shows the name to allow you to change it. To start over with another speed dial number, press **Back**.
5. Enter the name you want and press **OK**.
For details on how to enter alphanumeric characters, see page 29.
6. Enter the fax number you want and press **OK**.

7. Press **Stop/Clear** to return to ready mode.

Editing speed dial numbers

1. Press **Address Book** until **New & Edit** appears on the bottom line of the display and press **OK**.
2. Press **OK** when **Speed Dial** appears.
3. Enter the speed dial number you want to edit and press **OK**.
4. Change the name and press **OK**.
5. Change the fax number and press **OK**.
6. Press **Stop/Clear** to return to ready mode.

Using speed dial numbers

When you are prompted to enter a destination number while sending a fax, enter the speed dial number at which you stored the number you want.

- For a one-digit (0-9) speed dial number, press and hold the corresponding digit button on the number keypad.
- For a two- or three-digit speed dial number, press the first digit button(s) and then hold down the last digit button.

You can also search through memory for an entry by pressing **Address Book**. See page 57.

Group dial numbers

If you frequently send the same document to several destinations, you can group these destinations and set them under a group dial number. You can then use a group dial number to send a document to all of the destinations within the group. You can set up to 200 (0 through 199) group dial numbers using the destination's existing speed dial numbers.

Registering a group dial number

1. Press **Fax**.
2. Press **Address Book** until **New & Edit** appears on the bottom line of the display and press **OK**.
3. Press the left/right arrow until **Group Dial** appears and press **OK**.
4. Enter a group dial number between 0 and 199 and press **OK**.
5. Enter a speed dial number and press **OK**.
6. Press **OK** when speed dial information appears correctly.
7. Press **OK** when **Yes** appears.
8. Repeat steps 5 and 6 to include other speed dial numbers into the group.
9. When you have finished, press the left/right arrow to select **No** at the **Another No.?** prompt and press **OK**.
10. Press **Stop/Clear** to return to ready mode.

Editing a group dial number

You can delete a specific entry from a group or add a new number to the selected group.

1. Press **Address Book** until **New & Edit** appears on the bottom line of the display and press **OK**.
2. Press the left/right arrow until **Group Dial** appears and press **OK**.
3. Enter the group dial number you want to edit and press **OK**.
4. Enter the speed dial number you want to add or delete and press **OK**.
If you entered a new speed dial number, **Add?** appears.
If you enter a speed dial number stored in the group, **Delete?** appears.
5. Press **OK** to add or delete the number.
6. Press **OK** when **Yes** appears to add or delete more numbers and repeat steps 4 and 5.
7. When you have finished, press the left/right arrow to select **No** at the **Another No.?** prompt and press **OK**.

8. Press **Stop/Clear** to return to ready mode.

Using group dial numbers

To use a group dial entry, you need to search for and select it from memory.

When you are prompted to enter a fax number while sending a fax, press **Address Book**. See below.

Searching Address Book for an entry

There are two ways to search for a number in memory. You can either scan from A to Z sequentially, or you can search by entering the first letters of the name associated with the number.

Searching sequentially through the memory

1. If necessary, press **Fax**.
2. Press **Address Book** until **Search & Dial** appears on the bottom line of the display and press **OK**.
3. Press the left/right arrow until the number category you want appears and press **OK**.
4. Press **OK** when **All** appears.
5. Press the left/right arrow until the name and number you want appears. You can search upwards or downwards through the entire memory in alphabetical order.

Searching with a particular first letter

1. If necessary, press **Fax**.
2. Press **Address Book** until **Search & Dial** appears on the bottom line of the display and press **OK**.
3. Press the left/right arrow until the number category you want appears and press **OK**.
4. Press the left/right arrow until **ID** appears and press **OK**.
5. Enter the first few letters of the name you want and press **OK**.
6. Press the left/right arrow until the name you want appears and press **OK**.

Deleting a Address Book entry

You can delete entries in **Address Book** one by one.

1. Press **Address Book** until **Delete** appears on the bottom line of the display and press **OK**.
2. Press the left/right arrow until the number category you want appears and press **OK**.
3. Press the left/right arrow until the searching method you want appears and press **OK**.
Select **Search All** to search for an entry by scanning through all entries in **Address Book**.
Select **Search ID** to search for an entry by the first few letters of the name.
4. Press the left/right arrow until the name you want appears and press **OK**.
Or, enter the first letters and press **OK**. Press the left/right arrow until the name you want appears and press **OK**.
5. Press **OK**.
6. Press **OK** when **Yes** appears to confirm the deletion.
7. Press **Stop/Clear** to return to ready mode.

Printing Address Book

1. You can check your **Address Book** settings by printing a list.
 1. Press **Address Book** until **Print** appears on the bottom line of the display.
 2. Press **OK**. A list showing your speed button settings, and speed dial and group dial entries prints out.

using USB flash memory

This chapter explains how to use a USB memory device with your machine.

This chapter includes:

- About USB memory
- Plugging in a USB memory device
- Scanning to a USB memory device

ABOUT USB MEMORY

USB memory devices are available with a variety of memory capacities to give you more room for storing documents, presentations, downloaded music and videos, high resolution photographs, or whatever other files you want to store or move.

You can do the following on your machine using a USB memory device:

- Scan documents and save them on a USB memory device.
- Print data stored on a USB memory device.
- Back up **Address Book/ Phone Book** entries and the system settings of your machine.
- Restore backup files to the machine's memory.
- Format the USB memory device.
- Check the available memory space.

PLUGGING IN A USB MEMORY DEVICE

The USB memory port on the front of your machine is designed for USB V1.1 and USB V2.0 memory devices. Your machine supports USB memory devices with FAT16/FAT32 and sector size of 512 bytes. Check your USB memory device's file system from your dealer. You must use only an authorized USB memory device with an A plug type connector.

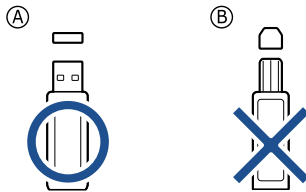

Use only a metal/shielded USB memory device.

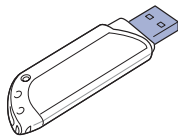

- Printing from a USB memory device
- Backing up data
- Managing USB memory

Insert a USB memory device into the USB memory port on the front of your machine.

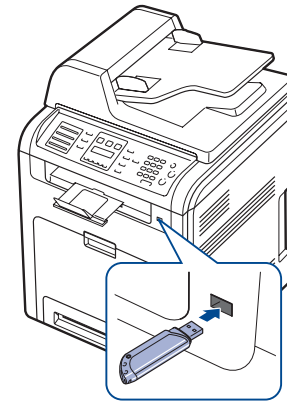

- ⚠ Do not remove the USB memory device while the machine is in operation, or writing to or reading from USB memory. The machine warranty does not cover damage caused by use's misuse.
- If your USB memory device has certain features, such as security settings and password settings, your machine may not automatically detect it. For details about these features, see the device's User's Guide.

SCANNING TO A USB MEMORY DEVICE

You can scan a document and save the scanned image onto a USB memory device. There are two ways of doing this: you can scan to the device using the default settings, or you can customize your own scan settings.

Scanning

1. Insert a USB memory device into the USB memory port on your machine.
2. Load originals face up into the DADF, or place a single original face down on the scanner glass.
For details about loading an original, see page 32.
3. Press **Scan/Email**.
4. Press **OK** when **Scan to USB** appears on the bottom line of the display.
5. Press **OK**, **Color Start** or **Black Start** when **USB** appears.
Regardless of the button you press, the color mode is decided as customized. See "Customizing Scan to USB" on page 59.
Your machine begins scanning the original, and then asks if you want to scan another page.

6. Press **OK** when **Yes** appears to scan more pages. Load an original and press **Color Start** or **Black Start**.
Regardless of the button you press, the color mode is decided as customized. See "Customizing Scan to USB" on page 59.
Otherwise, press the left/right arrow to select **No** and press **OK**.

After scanning is complete, you can remove the USB memory device from the machine.

Customizing Scan to USB

You can specify image size, file format, or color mode for each scanning to USB job.

1. Press **Scan/Email**.
2. Press **Menu** until **Scan Feature** appears on the bottom line of the display and press **OK**.
3. Press **OK** when **USB Memory** appears.
4. Press the left/right arrow until the setting option you want appears and press **OK**.
You can set the following options:
 - **Scan Size:** Sets the image size.
 - **Original Type:** Sets the original document's type.
 - **Resolution:** Sets the image resolution.
 - **Scan Color:** Sets the color mode. If you select Mono in this option, you cannot select JPEG in **Scan Format**.
 - **Scan Format:** Sets the file format in which the image is to be saved. When you select TIFF or PDF, you can select to scan multiple pages. If you select JPEG in this option, you cannot select Mono in **Scan Color**.
5. Press the left/right arrow until the desired status appears and press **OK**.
6. Repeat steps 4 and 5 to set other setting options.
7. When you have finished, press **Stop/Clear** to return to ready mode.

You can change the default scan settings. For details, see page 46.

PRINTING FROM A USB MEMORY DEVICE

You can directly print files stored on a USB memory device. You can print TIFF, BMP, JPEG, PDF, and PRN files.

Direct Print option supported file types:

- PRN: PCL 6 compatible.
- PRN files can be created by selecting the Print to file check box when you print a document. The document will be saved as a PRN file, rather than printed on paper. Only PRN files created in this fashion can be printed directly from USB memory. See the Software Section to learn how to create a PRN file.
- BMP: BMP Uncompressed
- TIFF: TIFF 6.0 Baseline
- JPEG: JPEG Baseline
- PDF: PDF 1.4 and below

To print a document from a USB memory device:

1. Insert a USB memory device into the USB memory port on your machine. If one has already been inserted, press **USB Print**.
Your machine automatically detects the device and reads data stored on it.
2. Press the left/right arrow until the folder or file you want appears and press **OK**.
If you see **D** in the front of a folder name, there are one or more files or folders in the selected folder.
3. If you selected a file, skip to the next step.
If you selected a folder, press the left/right arrow until the file you want

appears.

4. Press the left/right arrow to select the number of copies to be printed or enter the number.
5. Press **OK**, **Color Start** or **Black Start** to start printing the selected file.
There are two types of mode as following:
 - **OK or Color Start:** Color print
 - **Black Start:** Black and White printAfter printing the file, the display asks if you want to print another job.
6. Press **OK** when **Yes** appears to print another job, and repeat from step 2. Otherwise, press the left/right arrow to select **No** and press **OK**.
7. Press **Stop/Clear** to return to ready mode.



Can choose paper size and tray when printing. See "Setting the paper size and type" on page 38.

BACKING UP DATA

Data in the machine's memory can be accidentally erased due to power failure or storage failure. Backup helps you protect your **Address Book** entries and the system settings by storing them as backup files on a USB memory device.

Backing up data

1. Insert the USB memory device into the USB memory port on your machine.
2. Press **Menu** until **System Setup** appears on the bottom line of the display and press **OK**.
3. Press **OK** when **Machine Setup** appears.
4. Press the left/right arrow until **Export Setting** appears and press **OK**.
5. Press the left/right arrow until the option you want appears.
 - **Address Book:** Backs up all **Address Book** entries.
 - **Setup Data:** Backs up all system settings.
6. Press **OK** to begin backing up the data.
The data is backed up to the USB memory.
7. Press **Stop/Clear** to return to ready mode.

Restoring data

1. Insert the USB memory device on which the backup data is stored in to the USB memory port.
2. Press **Menu** until **System Setup** appears on the bottom line of the display and press **OK**.
3. Press **OK** when **Machine Setup** appears.
4. Press the left/right arrow until **Import Setting** appears and press **OK**.
5. Press the left/right arrow until the data type you want appears and press **OK**.
6. Press the left/right arrow until the file containing the data you want to restore appears and press **OK**.
7. Press **OK** when **Yes** appears to restore the backup file to the machine.
8. Press **Stop/Clear** to return to ready mode.

MANAGING USB MEMORY

You can delete image files stored on a USB memory device one by one or all at once by reformatting the device.

 After deleting files or reformatting a USB memory device, files cannot be restored. Therefore, confirm that you no longer need the data before deleting it.

Deleting an image file

1. Insert the USB memory device into the USB memory port on your machine.
2. Press **Scan/Email**.
3. Press **OK** when **Scan to USB** appears on the bottom line of the display.
4. Press the left/right arrow until **File Manage** appears and press **OK**.
5. Press **OK** when **Delete** appears.
6. Press the left/right arrow until the folder or file you want appears and press **OK**.

 If you see **D** in the front of a folder name, there are one or more files or folders in the selected folder.

If you selected a file, the display shows the size of the file for about 2 seconds. Go to the next step.

If you selected a folder, press the left/right arrow until the file you want to delete appears and press **OK**.

7. Press **OK** when **Yes** appears to confirm your selection.
8. Press **Stop/Clear** to return to ready mode.

Formatting a USB memory device

1. Insert the USB memory device into the USB memory port on your machine.
2. Press **Scan/Email**.
3. Press **OK** when **Scan to USB** appears on the bottom line of the display.
4. Press the left/right arrow until **File Manage** appears and press **OK**.
5. Press the left/right arrow until **Format** appears and press **OK**.
6. Press **OK** when **Yes** appears to confirm your selection.
7. Press **Stop/Clear** to return to ready mode.

Viewing the USB memory status

You can check the amount of memory space available for scanning and saving documents.

1. Insert the USB memory device into the USB memory port on your machine.
2. Press **Scan/Email**.
3. Press **OK** when **Scan to USB** appears on the bottom line of the display.
4. Press the left/right arrow until **Check Space** appears and press **OK**.
The available memory space appears on the display.
5. Press **Stop/Clear** to return to the ready mode.

maintenance

This chapter provides information for maintaining your machine and the toner cartridge.

This chapter includes:

- Printing reports
- Adjusting the color contrast
- Clearing memory
- Cleaning your machine
- Maintaining the cartridge

PRINTING REPORTS

Your machine can provide various reports with useful information you will need. The following reports are available:

-  Some reports may not appear in the display depending on options or models. If so, it is not applicable to your machine.

REPORT/LIST	DESCRIPTION
Configuration	This list shows the status of the user-selectable options. You may print this list to confirm your changes after changing settings.
Supplies Info	This list shows the current status of consumables in your machine.
Address Book	This list shows all of the fax numbers and email addresses currently stored in the machine's memory.
Send Report	This report shows the fax number, the number of pages, the elapsed time of the job, the communication mode, and the communication results for a particular fax job. You can set up your machine to automatically print a transmission confirmation report after each fax job. See page 55.
Sent Report	This report shows information on the faxes and emails you have recently sent. You can set the machine to automatically print this report every 50 communications. See page 55.
Fax RCV Report	This report shows information on the faxes you have recently received.
Schedule Jobs	This list shows the documents currently stored for delayed faxes along with the starting time and type of each operation.
Junk Fax Report	This list shows the fax numbers specified as junk fax numbers. To add or delete numbers to or from this list, access the Junk Fax Setup menu. See page 55.
Network Info.	This list shows information on your machine's network connection and configuration.

- Replacing the toner cartridge
- Replacing the paper transfer belt
- Maintenance parts
- Managing your machine from the website
- Checking the machine's serial number

REPORT/LIST	DESCRIPTION
NetScan Report	This report shows information for the Network Scan records including IP address, time and date, the number of pages scanned, and results. This report is automatically printed every 50 network scan jobs.
User Auth List	This list shows authorized users who are allowed to use the email function.
PCL Font List	You can print the PCL font list.
PS3 Font List	You can print the PS3 font list.
Stored Job	This list shows the current status of stored job on HDD.
Completed Job	The Completed Job page shows the list of completed print jobs. The list contains up to 50 files from the latest print jobs.
Net Auth Log	This list shows users and their IDs who logged in the domain.

Printing a report

1. Press **Menu** until **System Setup** appears on the bottom line of the display and press **OK**.
2. Press the left/right arrow until **Report** appears and press **OK**.
3. Press the left/right arrow until the report or list you want to print appears and press **OK**.
To print all reports and lists, select **All Report**.
4. Press **OK** when **Yes** appears to confirm printing.
The selected information prints out.

ADJUSTING THE COLOR CONTRAST

Color menu allows you to adjust the color setting.

1. Press **Menu** until **System Setup** appears on the bottom line of the display and press **OK**.
2. Press **OK** when **Maintenance** appears.
3. Press the left/right arrow until **Color** appears and press **OK**.
4. Press the left/right arrow until the menu you want appears on display and press **OK**.
 - **Custom Color:** Allows you to adjust contrast color by color. **Default** optimizes color automatically. **Manual Adjust** allows you to manually adjust the color contrast for each cartridge. **Default** setting is recommended for getting best color quality.
 - **Auto Color Reg.:** Allows you to adjust the position of print color

texts or graphics to match the original file on your screen.

 If you have moved the machine, it is strongly recommended to operate this menu manually.

5. Press **Stop/Clear** to return to ready mode.

CLEARING MEMORY

You can selectively clear information stored in your machine's memory.

 Before clearing the memory, make sure that all fax jobs have been completed, or you will lose those jobs.

1. Press **Menu** until **System Setup** appears on the bottom line of the display and press **OK**.
2. Press the left/right arrow until **Clear Setting** appears and press **OK**.
3. Press the left/right arrow until the item you want to clear appears.

 Some menus may not appear in the display depending on options or models. If so, it is not applicable to your machine.

OPTIONS	DESCRIPTION
All Settings	Clears all of the data stored in memory and resets all of your settings to the factory default.
Fax Setup	Restores all of the fax options to the factory default.
Copy Setup	Restores all of the copy options to the factory default.
Scan Setup	Restores all of the scan options to the factory default.
System Setup	Restores all of the system options to the factory default.
Network	Restores all of the network options to the factory default.
Address Book	Clears all of the fax number and email address entries stored in memory.
Sent Report	Clears all records of sent faxes and emails.
Fax RCV Report	Clears all records of received faxes.
NetScan Report	Clears the information on network scan sessions in memory.

4. Press **OK** when **Yes** appears.
5. Press **OK** again to confirm clearing.
6. Repeat steps 3 through 5 to clear another item.
7. Press **Stop/Clear** to return to ready mode.

CLEANING YOUR MACHINE

To maintain print and scan quality, follow the cleaning procedures below each time the toner cartridge is replaced or if print and scan quality problems occur.

-  • Cleaning the cabinet of the machine with cleaning materials containing large amounts of alcohol, solvent, or other strong substances can discolor or distort the cabinet.
- If your machine or its surrounding is contaminated with toner, we recommend you to use cloth or tissue dampened with water to clean it. If you use a vacuum cleaner, toner blown into the air may be harmful.

Cleaning the outside

Clean the cabinet of the machine with a soft lint-free cloth. You can dampen the cloth slightly with water, but be careful not to let any water drip onto or into the machine.

Cleaning the inside

During the printing process, paper, toner, and dust particles can accumulate inside the machine. This buildup can cause print quality problems, such as toner specks or smearing. Cleaning the inside of the machine clears or reduces these problems.

1. Turn the machine off and unplug the power cord. Wait for the machine to cool down.
2. Using the handle, completely open the front cover.

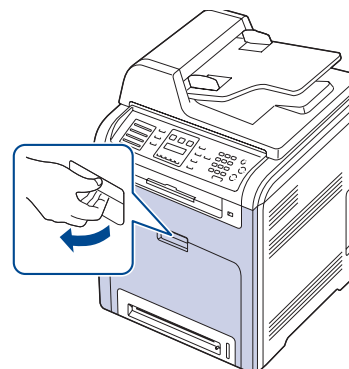

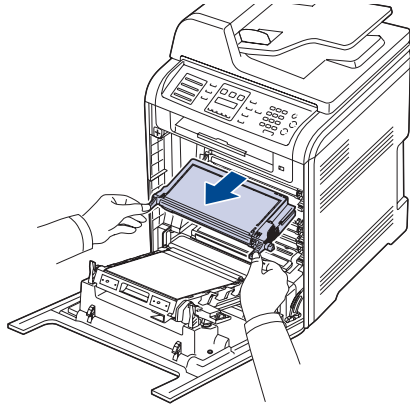

-  • Do not touch the green surface, the OPC drum or the front of the toner cartridge, with your hands or any other material. Use the handle on each cartridge in order to avoid touching this area.
- Be careful not to scratch the surface of the paper transfer belt.
- If you leave the front cover open for more than a few minutes, the OPC drum can be exposed to light. This will cause damage to the OPC drum. Close the front cover should the installation need to be halted for any reason.

3. Grasp the handles on the toner cartridge and pull to remove the cartridge from the machine.

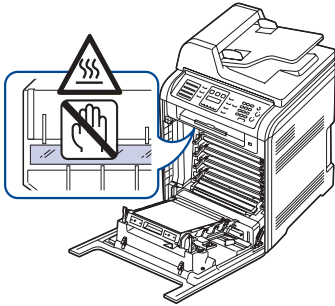

-  When you open the front cover, be careful not to touch the underneath of the control panel (the lower part of the fuser unit). The temperature of the fuser unit might be high and could damage your skin.



-  When you open the front cover and work inside the machine, it is highly recommend that you remove the paper transfer belt first. Because the work you do could contaminate the paper transfer belt.
4. Press the green release handle to release the paper transfer belt. Holding the handle on the paper transfer belt, lift it out of the machine.

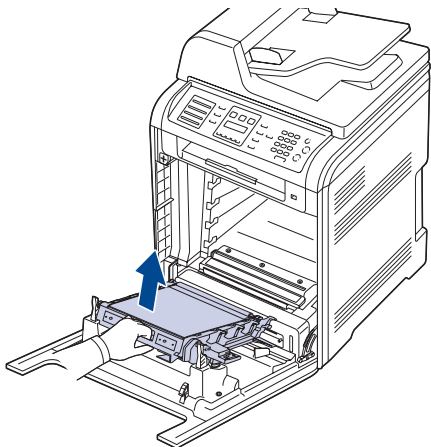

5. With a dry lint-free cloth, wipe away any dust and spilled toner from the toner cartridges area and their cavities.

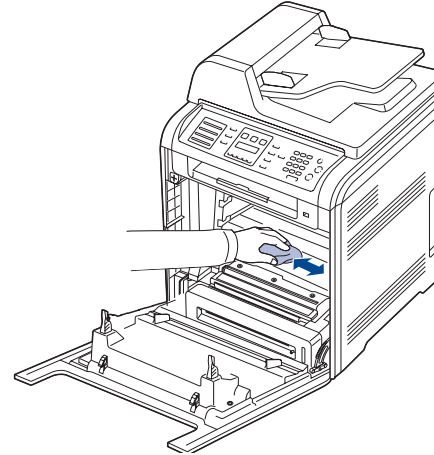

-  If toner gets on your clothing, wipe it off with a dry cloth and wash it in cold water. Hot water sets toner into fabric.

6. Locate the long strip of glass (LSU) inside the cartridge compartment, and gently swab the glass to see if dirt turns the white cotton black.

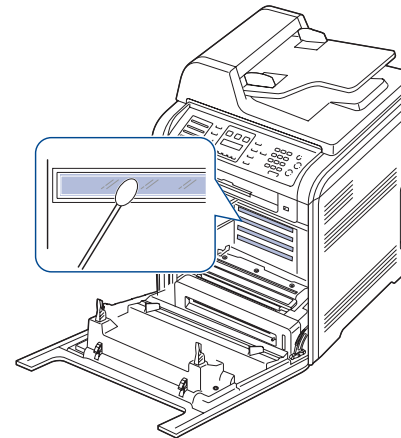

7. Reinstall all the compartments into the machine, and close the front cover.

-  If the front cover is not completely closed, the machine will not operate.

8. Plug in the power cord and turn the machine on

Cleaning the scan unit

Keeping the scan unit clean helps ensure the best possible copies. We suggest that you clean the scan unit at the start of each day and during the day, as needed.

1. Slightly dampen a soft lint-free cloth or paper towel with water.
2. Open the scanner lid.
3. Wipe the surface of the scanner glass and DADF glass until it is clean and dry.

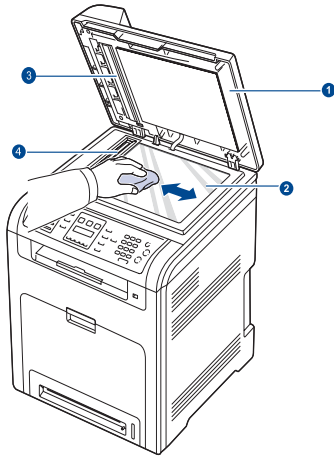

- | | |
|---|---------------|
| 1 | Scanner lid |
| 2 | Scanner glass |
| 3 | White sheet |
| 4 | DADF glass |

4. Wipe the underside of the scanner lid and white sheet until it is clean and dry.
5. Close the scanner lid.

MAINTAINING THE CARTRIDGE

Toner cartridge storage

To get the most from the toner cartridge, keep the following guidelines in mind:

- Do not remove the toner cartridge from its package until ready for use.
- Do not refill the toner cartridge. The machine warranty does not cover damage caused by using a refilled cartridge.
- Store toner cartridges in the same environment as your machine.
- To prevent damage to the toner cartridge, do not expose it to light for more than a few minutes.

Expected cartridge life

The life of the toner cartridge yield depends on the amount of toner that print jobs require. The actual number may also be different depending on the print density of the pages you print on, and the number of pages may be affected by operating environment, printing interval, media type, and media size. If you print a lot of graphics, you may need to change the cartridge more often.

Redistributing toner

When a toner is low, faded or light areas may appear. It is possible that colored images may be printed with incorrect colors due to flawed mixing of toner colors when one of the colored toner cartridges is low on toner. You can temporarily improve print quality by redistributing the toner.

- The toner-related message saying that the toner is low may appear on the display.
- The SmartPanel program window appears on the computer telling you which color cartridge is low on toner.

1. Using the handle, completely open the front cover.

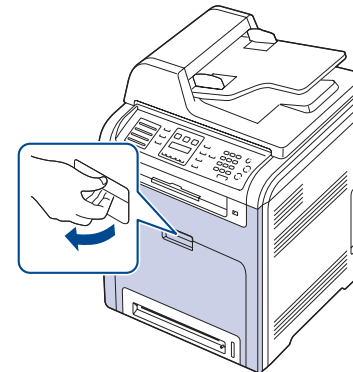

- ⚠ • Do not touch the green surface, the OPC drum or the front of the toner cartridge, with your hands or any other material. Use the handle on each cartridge in order to avoid touching this area.
- Be careful not to scratch the surface of the paper transfer belt.
- If you leave the front cover open for more than a few minutes, the OPC drum can be exposed to light. This will cause damage to the OPC drum. Close the front cover should the installation need to be halted for any reason.

- Grasp the handles on the toner cartridge and pull to remove the cartridge from the machine.

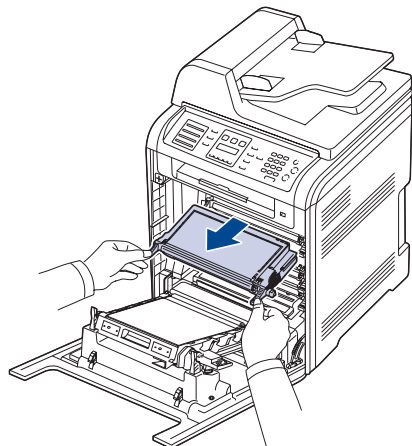

- !** When you open the front cover, be careful not to touch the underneath of the control panel (the lower part of the fuser unit). The temperature of the fuser unit might be high and could damage your skin.

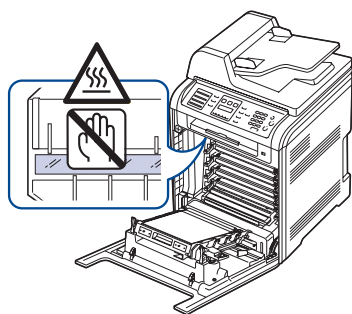

- !** When you open the front cover and work inside the machine, it is highly recommend that you remove the paper transfer belt first. Because the work you do could contaminate the paper transfer belt.
- Holding both handles on the toner cartridge, thoroughly rock it from side to side to evenly distribute the toner.

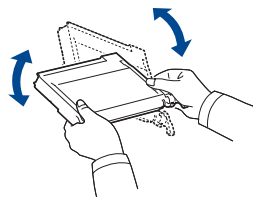

- !** If toner gets on your clothing, wipe it off with a dry cloth and wash it in cold water. Hot water sets toner into fabric.

- Slide the toner cartridge back into the machine.

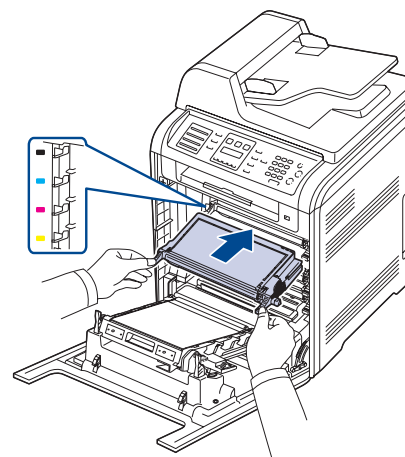

- Close the front cover. Make sure the cover is securely latched.

- !** If the front cover is not completely closed, the machine will not operate.

REPLACING THE TONER CARTRIDGE

The machine uses four colors and has a different toner cartridge for each one: yellow (Y), magenta (M), cyan (C), and black (K).

- The status LED and the toner-related message on the display indicates which each individual toner cartridge should be replaced.
- Incoming incoming faxes are saved in memory.

At this stage, the toner cartridge needs to be replaced. Check the type of toner cartridge for your machine. (See "" on page 90.)

- Turn the machine off, then wait a few minutes for the machine to cool.
- Using the handle, completely open the front cover.

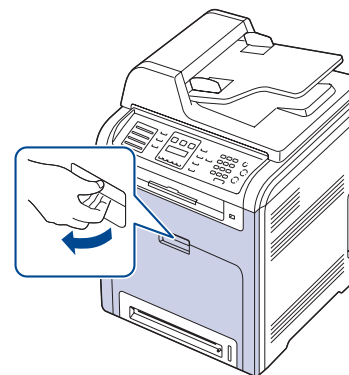

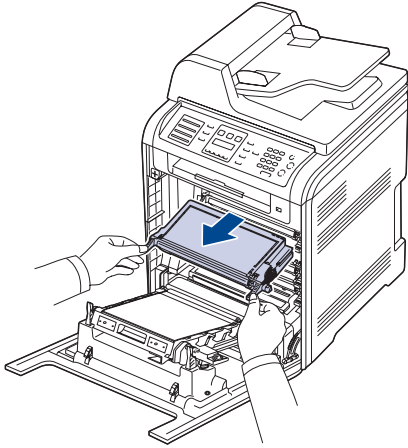

- !**
- Do not touch the green surface, the OPC drum or the front of each toner cartridge, with your hands or any other material. Use the handle on each cartridge in order to avoid touching this area.
 - Be careful not to scratch the surface of the paper transfer belt.
 - If you leave the front cover open for more than a few minutes, the OPC drum can be exposed to light. This will cause damage to the OPC drum. Close the front cover should the installation need to be halted for any reason.

3. Grasp the handles on the toner cartridge and pull to remove the cartridge from the machine.

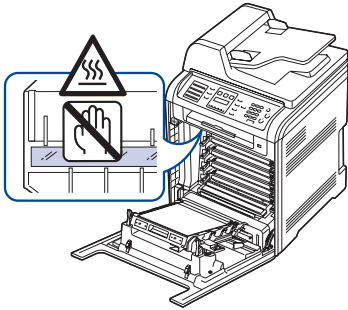

-  When you open the front cover, be careful not to touch the underneath of the control panel (the lower part of the fuser unit). The temperature of the fuser unit might be high and could damage your skin.



-  When you open the front cover and work inside the machine, it is highly recommend that you remove the paper transfer belt first. Because the work you do could contaminate the paper transfer belt.
4. Take a new toner cartridge out of its package.



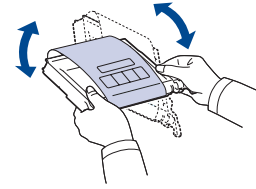

-  • Don't use sharp objects, such as a knife or scissors, to open the toner cartridge package. You could damage the surface of the toner cartridge.
- To prevent damage, do not expose the toner cartridge to light for more than a few minutes. Cover it with a piece of paper to protect it if necessary.

5. Holding both handles on the toner cartridge, thoroughly rock it from side to side to evenly distribute the toner.

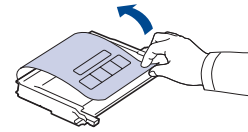

6. Place the toner cartridge on a flat surface, as shown, and remove the paper covering the toner cartridge by removing the tape.



-  If toner gets on your clothing, wipe it off with a dry cloth and wash it in cold water. Hot water sets toner into fabric.

7. Make sure that the color of the toner cartridge matches the color slot and then grasp the handles on the toner cartridge. Insert the cartridge until it clicks into place.

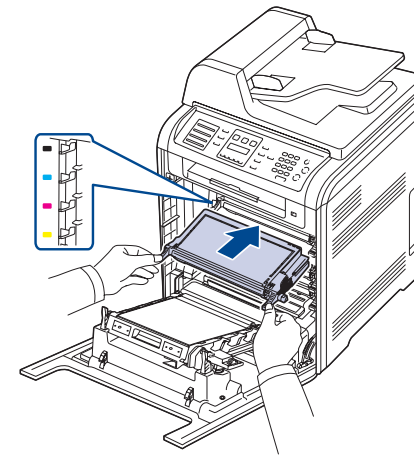

8. Close the front cover. Make sure the cover is securely latched, and then turn the machine on.

-  If the front cover is not completely closed, the machine will not operate.

Clearing the Toner Empty message

When the **Toner Empty** message appears you can configure not to see this message again not to disturb you.

1. Press **Menu** until **System Setup** appears on the bottom line of the display and press **OK**.
2. Press the Scroll buttons until **Maintenance** appears and press **OK**.
3. Press the Scroll buttons until **CLR Empty Msg.** appears and press **OK**.
4. Press the left/right arrow until the color menu you want appears on display and press **OK**.
5. Select **On** and press **OK**.

6. Now the **Toner Empty** message does not appear but the **Replace Toner** message will remain for reminding you that the new cartridge needs to be installed for quality.

- ⚠
- Once you have selected **On**, this setting will be permanently written to the memory of the toner cartridge, and this menu will be disappeared from the **Maintenance** menu.
 - You can keep printing but the quality cannot be guaranteed, and the product support is no longer provided.

REPLACING THE PAPER TRANSFER BELT

The life of the paper transfer belt is approximately 50,000 black and color pages. After the life span of the paper transfer belt is complete, you have to replace it.

- The transfer belt-related message appears on the display, telling it is time for a replacement.
- The SmartPanel program window appears on the computer telling you the paper transfer belt needs to be replaced.

✍ The life span of the paper transfer belt may be affected by operating environment, printing interval, media type, and media size.

1. Turn the machine off, then wait a few minutes for the machine to cool.
2. Using the handle, completely open the front cover.

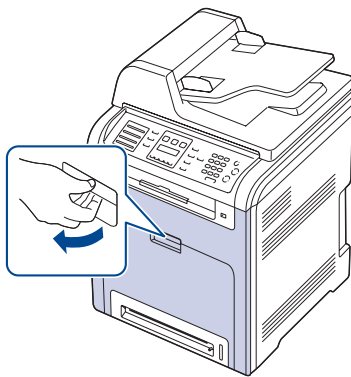

3. Press the green release handle to release the paper transfer belt. Holding the handle on the paper transfer belt, lift it out of the machine.

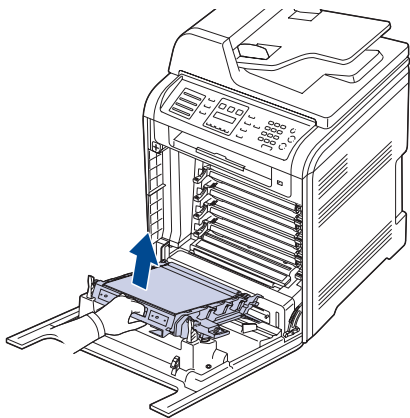

4. Take a new paper transfer belt out of its package.

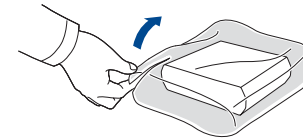

- ⚠
- Don't use sharp objects, such as a knife or scissors, to open the paper transfer belt package. You could damage the surface of the paper transfer belt.
 - Be careful not to scratch the surface of the paper transfer belt.

5. Holding the handle on the new paper transfer belt, align it with the slots on the inside of the front cover.

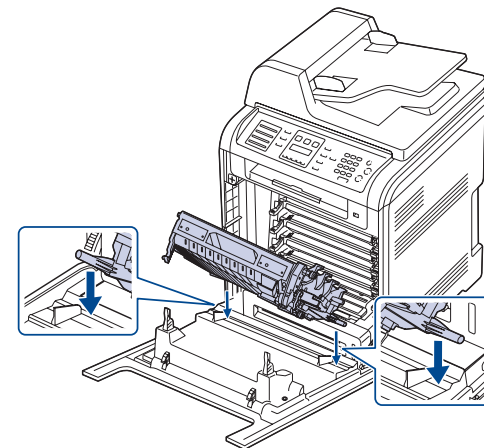

6. Lower the paper transfer belt until it is parallel with the front cover and firmly seated.

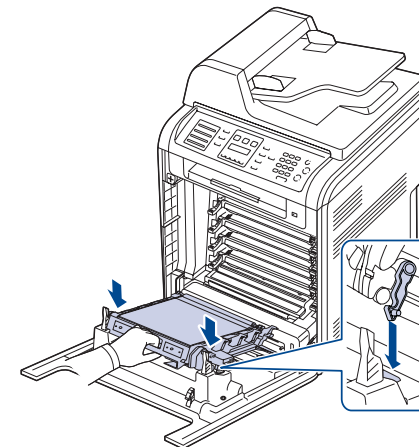

7. Close the front cover firmly.
8. Turn the machine on.

MAINTENANCE PARTS

To avoid print quality and paper feed problems resulting from worn parts, and to maintain your machine in top working condition the following condition, the following items will need to be replaced after the specified number of pages, or when the life span of each item has expired.

ITEMS	YIELD (AVERAGE)
Fuser unit	Approx. 100,000 pages
DADF friction pad	Approx. 20,000 pages
DADF pick-up roller	Approx. 80,000 pages
Pick-up roller (Multi-purpose tray, FCF ^a , Optional tray 2)	Approx. 70,000 pages
Friction pad (Multi-purpose tray, FCF, Optional tray 2)	Approx. 70,000 pages

a. First cassette feeder (Tray1)

We highly recommend that this maintenance be performed by an authorized service provider, dealer or the retailer where you bought the machine. The warranty does not cover the replacement of the maintenance parts after their lifespan.

Checking replaceables

If you experience frequent paper jams or printing problems, check the number of pages the machine has printed or scanned. Replace the corresponding parts, if necessary.

1. Press **Menu** until **System Setup** appears on the bottom line of the display and press **OK**.
2. Press the left/right arrow until **Maintenance** appears and press **OK**.
3. Press the left/right arrow until **Supplies Life** appears and press **OK**.
4. Press the left/right arrow until the item you want appears and press **OK**.
 - **Supplies Info:** Prints the supply information page.
 - **Total:** Displays the total number of pages printed.
 - **ADF Scan:** Displays the number of pages scanned using the ADF.
 - **Platen Scan:** Displays the number of pages scanned using the scanner glass.
 - **Transfer Belt, Fuser, Tray1 Roller, Tray2 Roller, MP Tray Roller:** Displays the number of pages printed each item.
5. If you selected to print a supply information page, press **OK** to confirm.
6. Press **Stop/Clear** to return to ready mode.

Replacing the DADF rubber pad

You will need to replace the DADF (or ADF) rubber pad when there seems to be a consistent problem with paper pickup or when its specified yield is reached.

For the DADF

1. Open the DADF cover.
2. Remove the DADF rubber pad from the DADF, as shown.

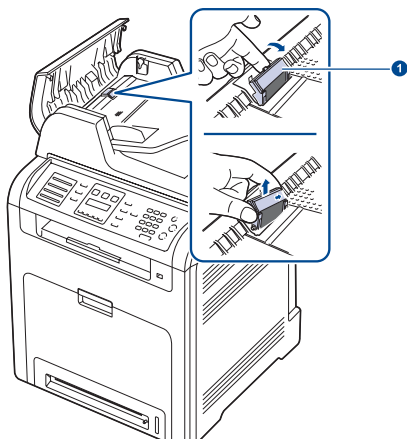

1 DADF rubber pad

3. Insert a new DADF rubber pad into place.
4. Close the DADF cover.

MANAGING YOUR MACHINE FROM THE WEBSITE

If you have connected your machine to a network and set up TCP/IP network parameters correctly, you can manage the machine via **SyncThru™ Web Service**, an embedded web server. Use **SyncThru™ Web Service** to:

- View the machine's device information and check its current status.
- Change TCP/IP parameters and set up other network parameters.
- Change the printer properties.
- Set the machine to send email notifications to let you know the machine's status.
- Get support for using the machine.

To access SyncThru™ Web Service:

1. Start a web browser, such as Internet Explorer, from Windows.
2. Enter the machine IP address (<http://xxx.xxx.xxx.xxx>) in the address field and press the **Enter** key or click **Go**.

Your machine's embedded website opens.

troubleshooting

This chapter gives helpful information for what to do if you encounter an error.

This chapter includes:

- Tips for avoiding paper jams
- Clearing document jams
- Clearing paper jams
- Understanding display messages
- Solving other problems

TIPS FOR AVOIDING PAPER JAMS

By selecting the correct media types, most paper jams can be avoided.

When a paper jam occurs, follow the steps outlined on page 70.

- Follow the procedures on page 36. Ensure that the adjustable guides are positioned correctly.
 - Do not overload the tray. Ensure that the paper level is below the paper capacity mark on the inside of the tray.
 - Do not remove paper from the tray while your machine is printing.
 - Flex, fan, and straighten paper before loading.
 - Do not use creased, damp, or highly curled paper.
 - Do not mix paper types in a tray.
 - Use only recommended print media. (See "Setting the paper size and type" on page 38.)
 - Ensure that the recommended side of the print media is facing up in the tray, or facing down in the multi-purpose tray.
-

For the DADF

1. Remove any remaining pages from the DADF.
2. Open the DADF cover.

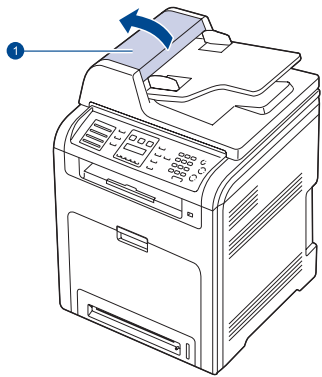

1 DADF cover

3. Pull the jammed paper gently out of the DADF.

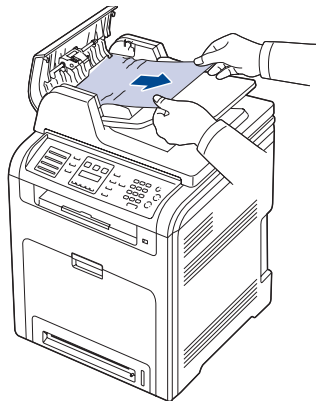

 This illustration may differ from your machine depending on its model.

4. Close the DADF cover. Then load the removed pages, if any, back into the DADF.

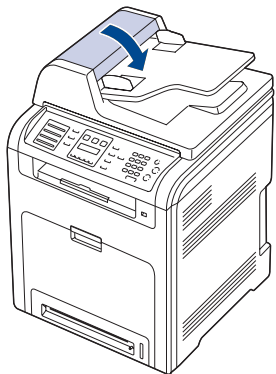

 To prevent document jams, use the scanner glass for thick, thin, or mixed paper-type originals.

Exit misfeed

1. Remove any remaining pages from the DADF.
2. Seize the misfeed paper, and remove the paper from the document output tray by carefully pulling it to the right using both hands.

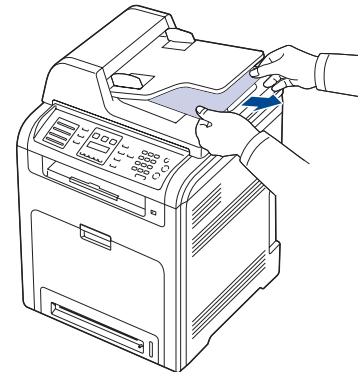

3. Load the removed pages back into the DADF.

Roller misfeed

1. Open the scanner lid.
2. Seize the misfeed paper, and remove the paper from the feed area by carefully pulling it to the right using both hands.

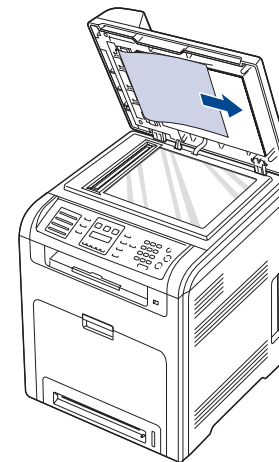



3. Close the scanner lid. Then load the removed pages back into the DADF.

CLEARING PAPER JAMS

When a paper jam occurs, the warning message appears on the display screen. Refer to the table below to locate and clear the paper jam.

MESSAGE	LOCATION OF JAM	GO TO
MP Tray Paper Jam 0	In the multi purpose tray	Page 73
Tray 2 Paper jam 0	In the optional tray	Page 76
Paper Jam 0 Open/Close Door	In the paper feed area or inside the machine	Page 72, Page 74
Paper Jam 1 Open/Close Door	Inside the machine	Page 72, Page 74
Paper Jam 2 Check Inside	Inside the machine or in the fuser area	Page 72, Page 74
Reverse Jam 0 Check Inside	In the fuser area or in the cover of reverse unit area	Page 72, Page 74
Reverse Jam 1 Check Inside	In the rear cover or in the cover of reverse unit area	Page 72, Page 75
Remove Paper in Rear Cover	Inside rear cover	Page 75
Duplex Jam 0 Check Inside	Inside the machine	Page 72
Duplex Jam 1 Open/Close Door	In the paper feed area or inside the machine	Page 72, Page 74

 Some messages may not appear in the display depending on options or models.

 To avoid tearing the paper, pull the jammed paper out gently and slowly. Follow the instructions in the following sections to clear the jam.

In the paper feed area

If paper is jammed in the paper feed area, follow the next steps to release the jammed paper.

- Using the handle, completely open the front cover.

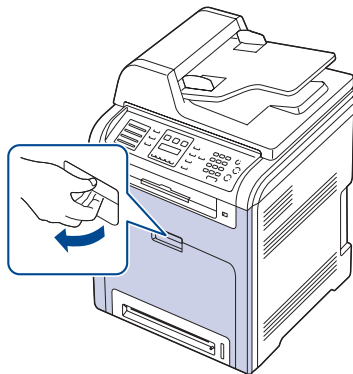

- Carefully remove the paper by pulling in the direction as shown below. Go to step 7.

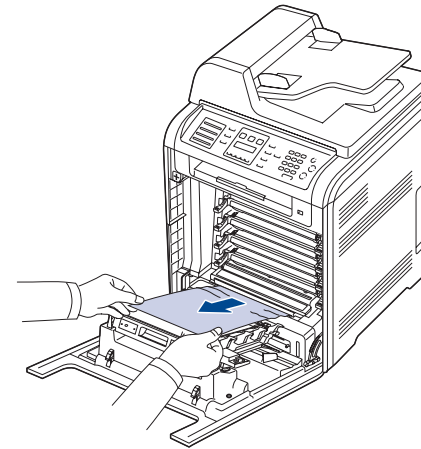

If you cannot find the jammed paper, or if there is any resistance removing the paper, stop pulling, and go to step 3.

-  • Do not touch the green surface, the OPC drum or the front of each toner cartridge, with your hands or any other material. Use the handle on each cartridge in order to avoid touching this area.
- Be careful not to scratch the surface of the paper transfer belt.
 - If you leave the front cover open for more than a few minutes, the OPC drum can be exposed to light. This will cause damage to the OPC drum. Close the front cover should the installation need to be halted for any reason.

- Close the front cover.
- Pull the tray open.

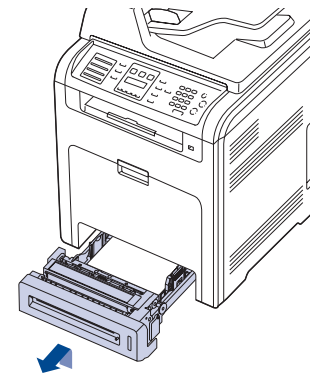

- Remove the jammed paper by gently pulling it straight out as shown below.

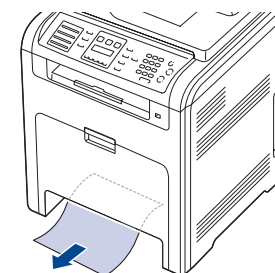

- To replace the tray, lower the rear edge, align it with the slot, and slide it into the machine.

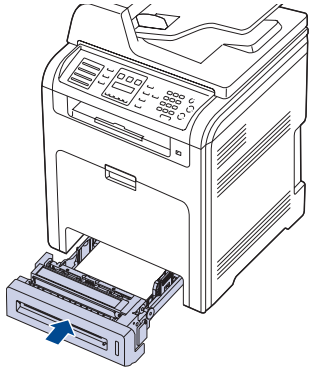

- Open the front cover and close it. The machine will resume printing.

In the multi-purpose tray

When you print using the Multi-purpose Tray and the machine detects that there is either no paper or that the paper has been improperly loaded, follow the next steps to release the jammed paper.

- Check if the paper is stuck in the feeding area, and if so, pull it out gently and slowly.

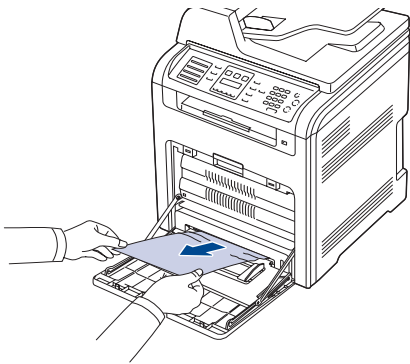

If you cannot find the jammed paper, or if there is any resistance removing the paper, stop pulling and go to step 2.

- Close the multi-purpose tray.
- Pull the tray out.
- Open the inner cover while you are pushing the lever with two hands.

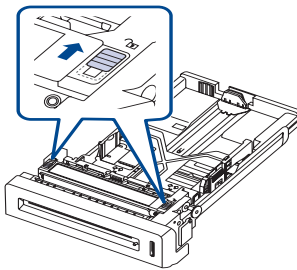

- Pull the paper out gently.

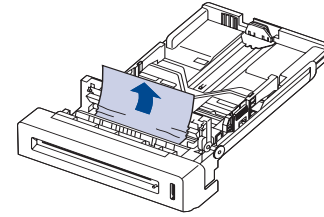

- Replace the tray.
If you cannot find the jammed paper, or if there is any resistance removing the paper, stop pulling and go to step 8.
- Using the handle, completely open the front cover.

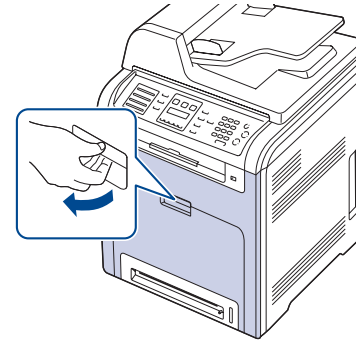

- Remove the jammed paper by pulling in the direction shown. To avoid tearing the paper, pull it out gently and slowly.

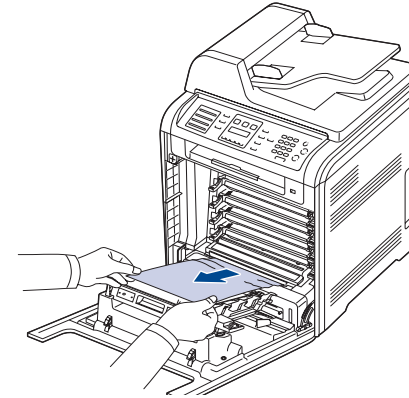

- ⚠ Do not touch the green surface, the OPC drum or the front of each toner cartridge, with your hands or any other material. Use the handle on each cartridge in order to avoid touching this area.
- Be careful not to scratch the surface of the paper transfer belt.
- If you leave the front cover open for more than a few minutes, the OPC drum can be exposed to light. This will cause damage to the OPC drum. Close the front cover should the installation need to be halted for any reason.

- Close the front cover firmly. The machine will resume printing.

- ⚠ If the front cover is not completely closed, the machine will not operate.

In the fuser unit area

If paper is jammed in the fuser unit area, follow the next steps to release the jammed paper.

1. Open the scan unit.

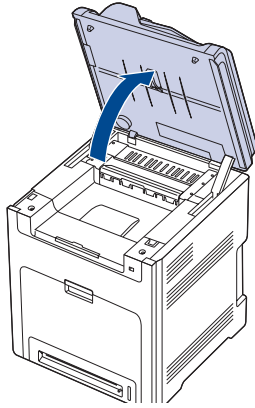

2. Open the inner cover using the handle.

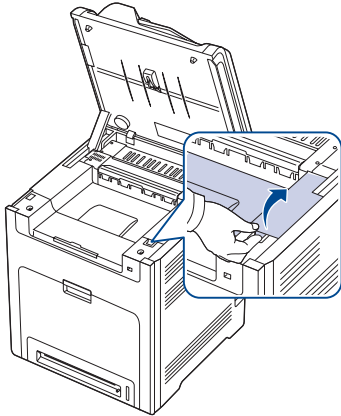

3. Open the inner cover using the handle on it and carefully take the jammed paper out of the machine.

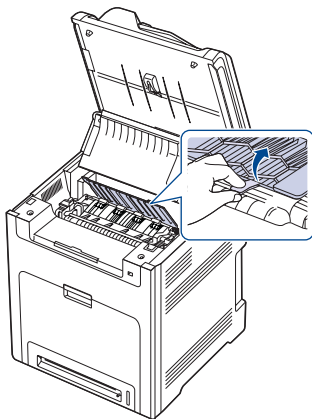

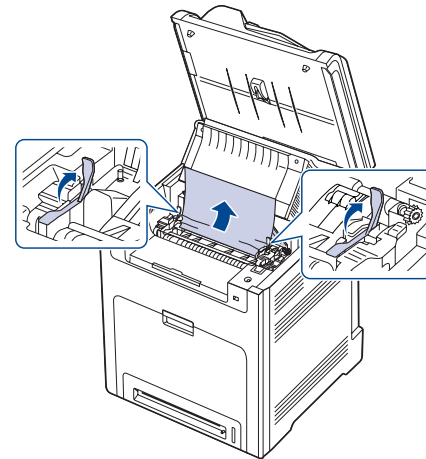

 Do not touch the fuser inside the inner cover. It is hot and could cause burns! The fuser's operating temperature is 180°C (356°F). Take care when removing paper from the machine.

4. Pull up the paper jam lever to loose the fusing part of the fuser unit and carefully take the jammed paper out of the machine.

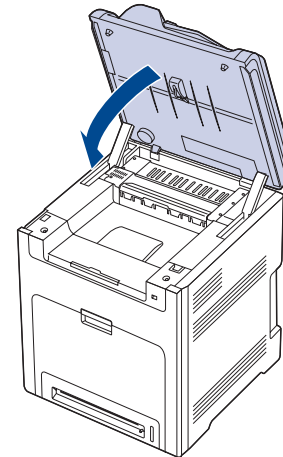

5. Press down the paper jam lever to fasten the fusing part.
6. Close the inner cover.
7. Lowering down the scan unit gently and slowly until it is completely closed. Make sure that it is securely latched. Be careful not to pinch your fingers!



 If the scan unit is not completely closed, the machine will not operate.

In the paper exit area

If paper is jammed in the paper exit area, follow the next steps to release the jammed paper.

1. If a long portion of the paper is visible, pull it straight out. Open and close the front cover firmly. The machine will resume printing.

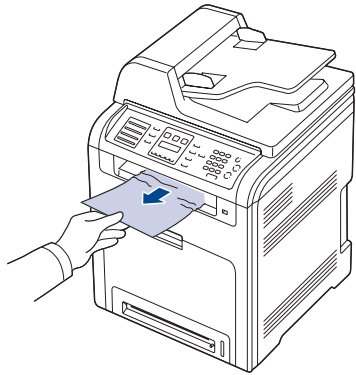

If you cannot find the jammed paper, or if there is any resistance removing the paper, stop pulling and go to step 2.

2. Open the scan unit.

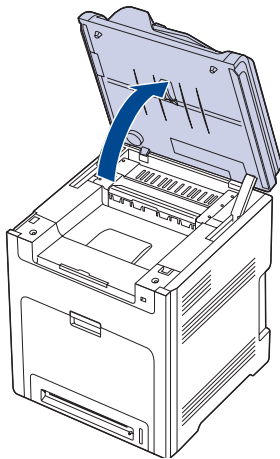

3. Open the cover of reverse unit using the handle on it and carefully take the jammed paper out of the machine.

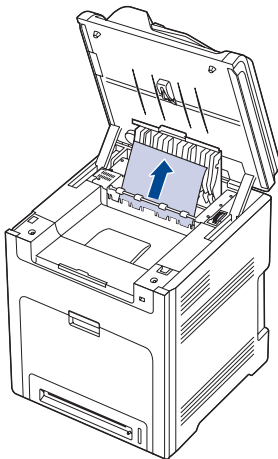

If there is any resistance removing the paper or difficulty picking up jammed paper, stop pulling and turn the release knob to the direction as shown to remove the misfed paper.

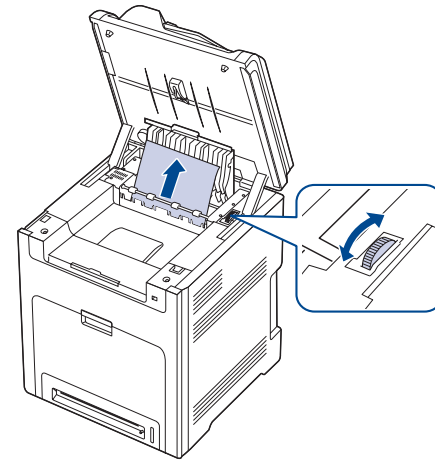

4. Close the cover of reverse unit.
5. Lowering down the scan unit gently and slowly until it is completely closed. Make sure that it is securely latched. Be careful not to pinch your fingers!

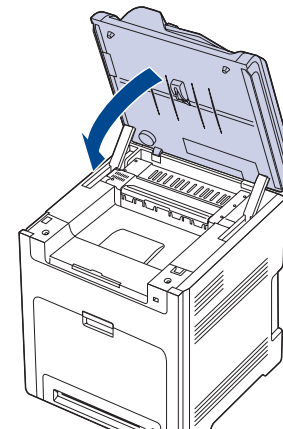

 If the scan unit is not completely closed, the machine will not operate.

If you cannot find the jammed paper, or if there is any resistance removing the paper, stop pulling and go to step 6.

6. Open the rear cover and carefully take the jammed paper out of the machine.

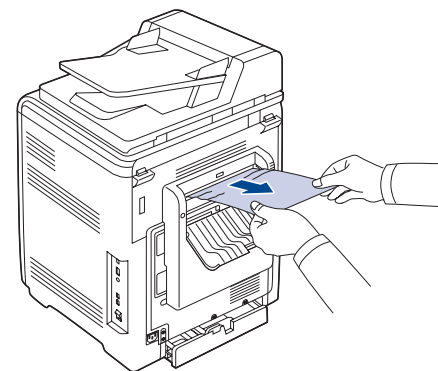

7. Close the rear cover.

In the optional tray

If paper is jammed in the optional Tray, follow the next steps to release the jammed paper.

1. Pull the optional Tray open. After you pull it all the way out, lift up the front part of the tray slightly to release the tray from the machine.

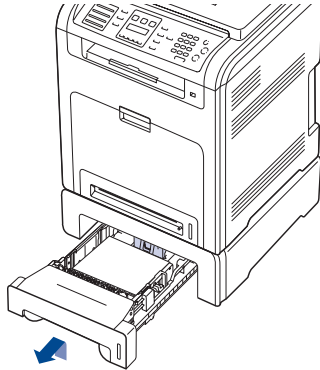

2. If you see the jammed paper, remove the paper from the machine by gently pulling it straight out as shown below.

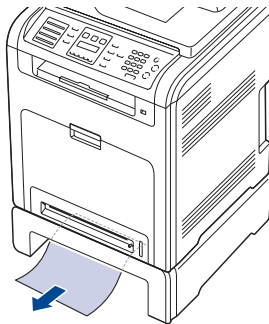

3. Slide the tray back into the machine.
4. Open the front cover.

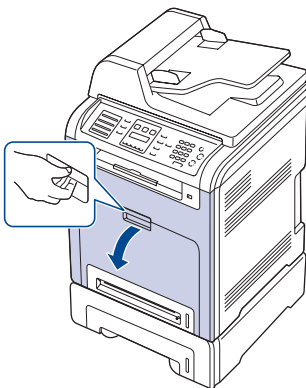

5. Pull the jammed paper out in the direction shown. To avoid tearing the paper, pull it out gently and slowly.

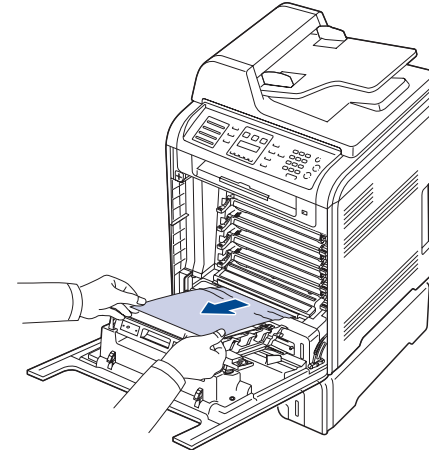

6. Close the front cover firmly. The machine will resume printing.



If the front cover is not completely closed, the machine will not operate.

UNDERSTANDING DISPLAY MESSAGES

Messages appear on the control panel display to indicate the machine's status or errors. Refer to the tables below to understand the messages' meaning and correct the problem if necessary. Messages and their meanings are listed in alphabetical order.

-  • If the message is not in the table, cycle the power and try the printing job again. If the problem persists, call for service.
- Some messages may not appear in the display depending on options or models.
- xxx indicates the media type.
- yyy indicates the tray.

MESSAGE	MEANING	SUGGESTED SOLUTIONS
[COMM. Error]	The machine has a communication problem.	Ask the sender to try again.
[Incompatible]	The machine has received a fax from which is registered as a junk fax.	The received fax data will be deleted. Reconfirm junk fax setup. See page 55
[Line Error]	Your machine cannot connect with the receiving fax machine or has lost contact because of a problem with the phone line.	Try again. If the problem persists, wait an hour or so for the line to clear and try again. Or, turn the ECM mode on. See page 55.
[No Answer]	The receiving fax machine has not answered after several redial attempts.	Try again. Make sure that the receiving machine is operational.
[Stop Pressed]	Stop/Clear has been pressed during an operation.	Try again.
[yyy] Paper Empty	There is no paper in the tray.	Load paper in the tray.
[yyy] Paper Mismatch	The paper size specified in the printer properties does not match the paper you are loading.	Load the correct paper in the tray.
[yyy] Cassette Out	The tray cassette is not properly closed.	To close the tray, lower the rear edge, align it with the slot, and slide it into the printer.
Adjusting... Registration	The machine is adjusting the color registration	Wait a few minutes.
Authentication Failure	The ID or password you entered is incorrect.	Enter the correct ID or password.

MESSAGE	MEANING	SUGGESTED SOLUTIONS
Cancel? ◀ Yes ▶	Your machine's memory has become full while trying to store an original into memory.	To cancel the fax job, press the OK button to accept Yes . If you want to send those pages that have been successfully stored, press the OK button to accept No . You should send the remaining pages later, when memory is available.
Connection Error	Connection with the SMTP server failed.	Check the server settings and the network cable.
Connection Failed	The protocol you have entered is not supported or server port is wrong.	Check the protocol or server port.
DADF Cover Open Error	The DADF cover is not securely latched.	Close the DADF cover until it locks into place.
Data Read Fail Check USB Mem.	Time expired while reading data.	Try again.
Data Write Fail Check USB Mem.	Storing to the USB memory failed.	Check the available USB memory space.
Document Jam	The loaded original has jammed in the DADF (or ADF).	Clear the jam. See page 70.
Door Open/Check Transfer Belt	The front cover is not securely latched.	Close the cover until it locks into place.
Duplex Jam 0 Check Inside	Paper has jammed during duplex printing. This is applicable only to machines with this feature.	Clear the jam. See page 72.
Duplex Jam 1 Open/Close Door	Paper has jammed during duplex printing. This is applicable only to machines with this feature.	Clear the jam. See page 72.
Enter Again	You entered an unavailable item.	Enter the correct item again.
File Access Denied	Login to the network server was successful. However, access to the file on the network server was denied.	Change the server settings.
File Format Not Supported	The selected file format is not supported.	Use the correct file format.

MESSAGE	MEANING	SUGGESTED SOLUTIONS
File Name Exist	The file name you have entered already exists.	Enter a different file name.
File Name Over Limit	The file names you can use are from doc001 to doc999. However, all file names are used already.	Delete unnecessary files.
Fuser Fan Locked	There is a problem in the cooling fan of the machine.	Open and then close the front cover.
Global Address Not Found	When the device is unable to locate the given address of the Global server.	Check the search ID.
Global Query Size Exceeded	This is an error message and displays when the global query size has been exceeded.	There are too many search results. Refine your search by entering more letters. Contact a LDAP server administrator.
Global Server Auth Failed	When there is a authentication fail while connecting to the global server this message displays.	Check the authentication account and password.
Global Server Not Configured	When no global server is configured, this message displays.	Check the LDAP server configuration settings.
Global Server Not Found	When the device is unable to find the Global server.	Check the LDAP server address, The LDAP server address is incorrect, or the server has failed.
Global Server Query Timeout	Network Information Center (NIC) failed to get the proper response from the LDAP server within specified time.	Check the LDAP server setting, LDAP server setting is incorrect.
Global Server Comm Error	This error message displays when there is a communication error between the global server and the device.	Try again. Contact a LDAP Server administrator.
Group Not Available	You have tried to select a group location number where only a single location number can be used, such as when adding locations for a Multiple Send operation.	Use a speed dial number or dial a number manually using the number keypad.

MESSAGE	MEANING	SUGGESTED SOLUTIONS
Install [xxx]	The corresponding part of the machine is not installed.	Install the part into your machine.
Invalid [xxx]	The color part of the machine is not for your machine.	Install the a Muratec genuine part designed for your machine.
Install Toner ▼	The color toner cartridge is not installed.	Install the color toner cartridge.
Invalid Toner ▼	The color toner cartridge you have installed is not for your machine.	Install the a Muratec-genuine color toner cartridge designed for your machine.
Invalid Server Address	The server address you have entered is invalid.	Enter the correct server address.
IP Conflict	The network IP address you have set is being used by someone else.	Check the IP address and reset it if necessary. See page 25.
Line Busy	The receiving fax machine did not answer or the line is already engaged.	Try again after a few minutes.
Low Power	The machine is in the previous stage of the power save mode.	When data is received, it switches to on-line automatically.
Mail Exceeds Server Support	The mail size is larger than the supported size by SMTP server.	Divide your mail or reduce the resolution.
Main Motor Locked	There is a problem in the main motor.	Open and then close the front cover.
Load Manually Press Start Key	The multi-purpose tray is empty in manual feed mode.	Load paper in the multi-purpose tray. See page 37.
Memory Full	The memory is full.	Delete unnecessary fax jobs and retransmit after more memory becomes available. Alternatively, split the transmission into more than one operation.
MP Tray Paper Jam 0	Paper has jammed in the feeding area of the multi-purpose tray.	Clear the jam. See page 72.
Network Error	There is a problem with the network.	Contact your network administrator.

MESSAGE	MEANING	SUGGESTED SOLUTIONS
Not Assigned	The speed button or speed dial number you tried to use has no number assigned to it.	Enter the number manually using the number keypad or store the number or address.
Not Available Try Again Later	Can not perform the task immediately because too many tasks are running at once.	Try again when current task is completed.
NonSAMSUNG Toner ▼	The color toner cartridge which the arrow indicates is not a Muratec-genuine cartridge. Press OK to toggle the message to Stop or Continue . ◀ Stop ▶	You can select either Stop or Continue with the left/right arrow. If you select Stop by pressing OK on the control panel, the machine stops printing. If you select Continue , the machine keeps printing, but the quality cannot be guaranteed. If you do not select any, the machine will work as Stop is selected. Replace the corresponding toner cartridge with a Samsung-genuine cartridge. See page 65.
One Page is Too Large	Single page data exceeds the configured mail size.	Reduce the resolution and try again.
Operation Not Assigned	You are in the Add Page/Cancel Job operation, but there are no jobs stored.	Check the display to see if there are any scheduled jobs.
Out-Bin Full	The output tray of the machine is full of paper.	Remove paper.
Paper Jam 0 Open/Close Door	Paper has jammed in the feeding area of the tray.	Clear the jam. See page 72.
Paper Jam 1 Open/Close Door	Paper has jammed inside the machine.	Clear the jam. See page 74.
Paper Jam 2 Check Inside	Special print media has jammed in the paper exit area.	Clear the jam. See page 75.
Power Failure	Power has turned off then on and the machine's memory has not been back up.	The job which you were trying to do before the power failure must be completely re-done.
Remove Paper in Rear Cover	Paper has jammed in the paper rear cover area.	Clear the jam. See page 75.

MESSAGE	MEANING	SUGGESTED SOLUTIONS
Refilled Toner ▼	The toner cartridge you have installed is not genuine or refilled.	The print quality may get poor if the refilled toner cartridge is installed, since its characteristics may significantly differ from the genuine. We recommend Muratec-genuine color toner cartridge.
Replace Toner ▼	This message appears between Toner Empty and Toner Low status.	Replace the toner cartridge with a new one. See page 65.
Replace [xxx]	The life of the part expires totally.	Replace the part with a new one. Call for service.
Replace [xxx] Soon	The life of the part expires soon.	See page 68 and call for service.
Retry Redial?	The machine is waiting for a specified time interval to redial a previously busy station.	You can press OK to immediately redial, or Stop/Clear to cancel the redial operation.
Reverse Jam 0 Check Inside	Paper has jammed in the paper fuser area and in the cover of reverse unit area.	Clear the jam. See page 75.
Reverse Jam 1 Check Inside	Paper has jammed in the cover of reverse unit area or in the rear cover.	Clear the jam. See page 74.
Scanner locked	The scanner module is locked	Unlock the scanner and press Stop/Clear .
Self Diagnostics Temperature	The engine in your machine is checking problems detected.	Wait a few minutes.
Self Diagnostics LSU	The LSU (Laser Scanning Unit) in your machine is checking problems detected.	Wait a few minutes.
Send Error (AUTH)	There is a problem in SMTP authentication.	Configure the authentication setting.
Send Error (DNS)	There is a problem in DNS.	Configure the DNS setting.
Send Error (POP3)	There is a problem in POP3.	Configure the POP3 setting.
Send Error (SMTP)	There is a problem in SMTP.	Change to the available server.

MESSAGE	MEANING	SUGGESTED SOLUTIONS
Send Error (Wrong Config)	There is a problem on the network interface card.	Configure your network interface card correctly.
Toner Empty ▼	<p>The color toner cartridge has run out. The machine stops printing. Press OK to toggle the message to Stop, Continue or Black Only.</p> <p>◀ Stop ▶</p> <p> If the black toner cartridge is empty, Black Only message does not appear.</p>	<p>You can select the option among Stop, Continue or Black Only with the left/right arrow. If you select Stop by pressing OK on the control panel, the machine stops printing. If you select Continue, the machine keeps printing, but the quality cannot be guaranteed. If you select Black Only, the machine prints the data in black. In this case, the mono printing feature is preset in the printer properties. When you copy, the Black Start button will be activated only with this condition. If you do not select any, the machine will work as Stop is selected. Replace the color toner cartridge with a new one. See page 65</p>
Toner Exhausted ▼	The lifespan of the color toner cartridge which the arrow indicates is reached.	This message appears when the toner is completely empty, and your machine stops printing. Replace the corresponding toner cartridge with a Muratec -genuine cartridge. See page 65.
Toner Low ▼	The corresponding color toner cartridge is almost empty.	Take out the toner cartridge and thoroughly shake it. By doing this, you can temporarily reestablish printing operations.
Tray 2 Paper jam 0	Paper has jammed in the paper feed area.	Clear the jam. See page 72.
Updating Data Please Wait...	This message appears when there is a change in the system setting or when you back up a data.	Do not turn the power off when this message is showing. Changes may not be saved and data can be lost.

SOLVING OTHER PROBLEMS

The following chart lists some conditions that may occur and the recommended solutions. Follow the suggested solutions until the problem is corrected. If the problem persists, call for service.

Paper feeding

CONDITION	SUGGESTED SOLUTIONS
Paper is jammed during printing.	Clear the paper jam. See page 70.
Paper sticks together.	<ul style="list-style-type: none"> • Ensure there is not too much paper in the tray. The tray can hold up to 250 sheets of paper, depending on the thickness of your paper. • Make sure that you are using the correct type of paper. See page 38. • Remove paper from the tray and flex or fan the paper. • Humid conditions may cause some paper to stick together.
Multiple sheets of paper do not feed.	<ul style="list-style-type: none"> • Different types of paper may be stacked in the tray. Load paper of only one type, size, and weight. • If multiple sheets have caused a paper jam, clear the paper jam. See page 70.
Paper does not feed into the machine.	<ul style="list-style-type: none"> • Remove any obstructions from inside the machine. • Paper has not been loaded correctly. Remove paper from the tray and reload it correctly. • There is too much paper in the tray. Remove excess paper from the tray. • The paper is too thick. Use only paper that meets the specifications required by the machine. See page 33. • If an original does not feed into the machine, the DADF rubber pad may require to be replaced. See page 68.
The paper keeps jamming.	<ul style="list-style-type: none"> • There is too much paper in the tray. Remove excess paper from the tray. If you are printing on special materials, use the multi-purpose tray. • An incorrect type of paper is being used. Use only paper that meets the specifications required by the machine. See page 33. • There may be debris inside the machine. Open the front cover and remove the debris. • If an original does not feed into the machine, the DADF rubber pad may require to be replaced. See page 68.
Envelopes skew or fail to feed correctly.	Ensure the paper guides are against both sides of the envelopes.

Printing problems

CONDITION	POSSIBLE CAUSE	SUGGESTED SOLUTIONS
The machine does not print.	The machine is not receiving power.	Check the power cord connections. Check the power switch and the power source.
	The machine is not selected as the default printer.	Select CLX-6240 Series as your default printer in your Windows.
	<ul style="list-style-type: none"> • Check the machine for the following: • The front cover is not closed. Close the cover. • Paper is jammed. Clear the paper jam. See page 72. • No paper is loaded. Load paper. See page 36. • The toner cartridge is not installed. Install the toner cartridge. • If a system error occurs, contact your service representative. 	
	The connection cable between the computer and the machine is not connected properly.	Disconnect the printer cable and reconnect it.
	The connection cable between the computer and the machine is defective.	If possible, attach the cable to another computer that is working properly and print a job. You can also try using a different printer cable.
	The port setting is incorrect.	Check the Windows printer setting to make sure that the print job is sent to the correct port. If the computer has more than one port, make sure that the machine is attached to the correct one.
	The machine may be configured incorrectly.	Check the printer properties to ensure that all of the print settings are correct.
	The printer driver may be incorrectly installed.	Repair the printer software. See the <i>Software section</i> .
	The machine is malfunctioning.	Check the display message on the control panel to see if the machine is indicating a system error.
	The document size is so big that the hard disk space of the computer is not enough to access the print job.	Get more hard disk space and print the document again.



CONDITION	POSSIBLE CAUSE	SUGGESTED SOLUTIONS
The machine selects print materials from the wrong paper source.	The paper source selection in the printer properties may be incorrect.	For many software applications, the paper source selection is found under the Thin Paper tab within the printer properties. Select the correct paper source. See the printer driver help screen.
A print job is extremely slow.	The job may be very complex.	Reduce the complexity of the page or try adjusting the print quality settings.
Half the page is blank.	The page orientation setting may be incorrect.	Change the page orientation in your application. See the printer driver help screen.
	The paper size and the paper size settings do not match.	Ensure that the paper size in the printer driver settings matches the paper in the tray. Or, ensure that the paper size in the printer driver settings matches the paper selection in the software application settings you use.
The machine prints, but the text is wrong, garbled, or incomplete.	The printer cable is loose or defective.	Disconnect the printer cable and reconnect. Try a print job that you have already printed successfully. If possible, attach the cable and the machine to another computer and try a print job that you know works. Finally, try a new printer cable.
	The wrong printer driver was selected.	Check the application's printer selection menu to ensure that your machine is selected.
	The software application is malfunctioning.	Try printing a job from another application.
	The operating system is malfunctioning.	Exit Windows and reboot the computer. Turn the machine off and then back on again.
Pages print, but are blank.	The toner cartridge is defective or out of toner.	Redistribute the toner, if necessary. See page 64. If necessary, replace the toner cartridge.
	The file may have blank pages.	Check the file to ensure that it does not contain blank pages.
	Some parts, such as the controller or the board, may be defective.	Contact a service representative.

CONDITION	POSSIBLE CAUSE	SUGGESTED SOLUTIONS
The printer does not print PDF file correctly. Some parts of graphics, text, or illustrations are missing.	Incompatibility between the PDF file and the Acrobat products.	Printing the PDF file as an image may solve this problem. Turn on Print As Image from the Acrobat printing options.  It will take longer to print when you print a PDF file as an image.
Your machine has an odd smell during initial use.	The oil used to protect the fuser is evaporating.	After printing about 100 color pages, there will be no more smell. It is a temporary issue.
The print quality of photos is not good. Images are not clear.	The resolution of the photo is very low.	Reduce the photo size. If you increase the photo size in the software application, the resolution will be reduced.
The machine prints, but the text is wrong, garbled, or incomplete.	If you are under the DOS environment, the font setting for your machine may be set incorrectly.	Suggested solutions: Change the font setting. See "Changing the font setting" on page 31.
Before printing, the machine emits vapor near the output tray.	Using damp paper can cause vapor during printing.	This is not a problem. Just keep printing.
The machine does not print special sized paper such as a billing paper.	Paper size and paper size setting do not match.	Set the correct paper size in the Custom in the Paper tab in the printer properties. See Software section.

Printing quality problems

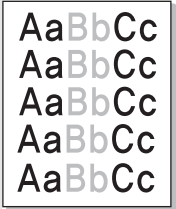

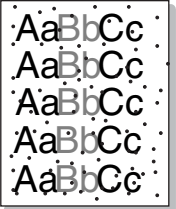
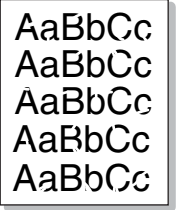
If the inside of the machine is dirty or paper has been loaded improperly, you may notice a reduction in print quality. See the table below to clear the problem.

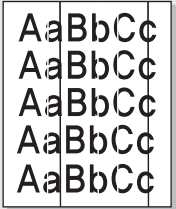
CONDITION	SUGGESTED SOLUTIONS
Light or faded print 	If a vertical white streak or faded area appears on the page: <ul style="list-style-type: none"> The toner supply is low. You may be able to temporarily extend the toner cartridge life. See page 65. If this does not improve the print quality, install a new toner cartridge. The paper may not meet paper specifications; for example, the paper is too moist or too rough. See page 33. If the entire page is light, the print resolution setting is too low. Adjust the print resolution. See the help screen of the printer driver. A combination of faded or smeared defects may indicate that the toner cartridge needs cleaning. The surface of the LSU part inside the machine may be dirty. Clean the LSU, contact a service representative.

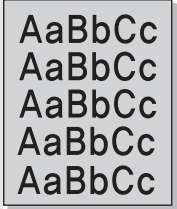
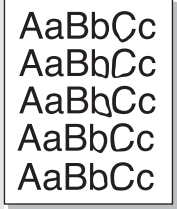
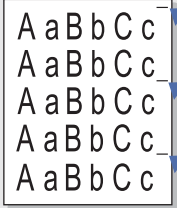
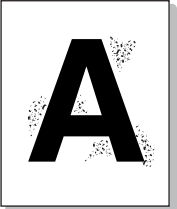
CONDITION	SUGGESTED SOLUTIONS
Toner specks 	<ul style="list-style-type: none"> The paper may not meet specifications; for example, the paper is too moist or too rough. See page 33. The paper path may need cleaning. See "Cleaning the inside" on page 62.
Dropouts 	<p>If faded areas, generally rounded, occur randomly on the page:</p> <ul style="list-style-type: none"> A single sheet of paper may be defective. Try reprinting the job. The moisture content of the paper is uneven or the paper has moist spots on its surface. Try a different brand of paper. See page 33. The paper lot is bad. The manufacturing processes can cause some areas to reject toner. Try a different kind or brand of paper. Change the printer option and try again. Go to printer properties, click Paper tab, and set type to Thick Paper. Refer to the <i>Software section</i> for details. <p>If these steps do not correct the problem, contact a service representative.</p>
White Spots 	<p>White spots appear on the page:</p> <ul style="list-style-type: none"> The paper is too rough and a lot of dirt from the paper falls to the inner devices within the machine, which means the transfer belt may be dirty. Clean the inside of your machine. Contact a service representative. The paper path may need cleaning. Contact a service representative.
Vertical lines 	<p>If black vertical streaks appear on the page:</p> <ul style="list-style-type: none"> The drum inside the toner cartridge has probably been scratched. Remove the toner cartridge and install a new one. See page 65. <p>If white vertical streaks appear on the page:</p> <ul style="list-style-type: none"> The surface of the LSU part inside the machine may be dirty. Clean the LSU, contact a service representative. <p>If vertical streaks appear on the page:</p> <ul style="list-style-type: none"> The surface of the scanner glass and its white sheet may be dirty. Clean these unit. See 64 . If this problem persists, contact a service representative.

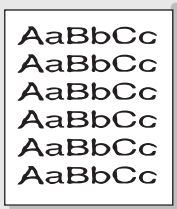
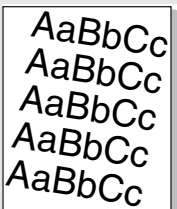
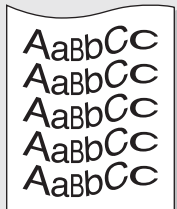
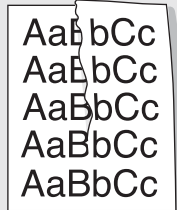
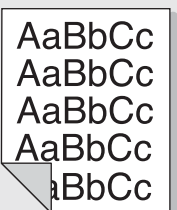
CONDITION	SUGGESTED SOLUTIONS
Color or Black background 	<p>If the amount of background shading becomes unacceptable:</p> <ul style="list-style-type: none"> • Change to a lighter weight paper. See page 33. • Check the machine's environment: very dry (low humidity) or high humidity (higher than 80% RH) conditions can increase the amount of background shading. • Remove the old toner cartridge and install a new one. See page 65.
Toner smear 	<ul style="list-style-type: none"> • Clean the inside of the machine. See page 62. • Check the paper type and quality. See page 33. • Remove the toner cartridge and install a new one. See page 65.
Vertical repetitive defects 	<p>If marks repeatedly appear on the printed side of the page at even intervals:</p> <ul style="list-style-type: none"> • The toner cartridge may be damaged. If a repetitive mark occurs on the page, print a cleaning sheet several times to clean the cartridge. After the printout, if you still have the same problems, remove the toner cartridge and install a new one. See page 65. • Parts of the machine may have toner on them. If the defects occur on the back of the page, the problem will likely correct itself after a few more pages. • The fusing assembly may be damaged. Contact a service representative.
Background scatter 	<p>Background scatter results from bits of toner randomly distributed on the printed page.</p> <ul style="list-style-type: none"> • The paper may be too damp. Try printing with a different batch of paper. Do not open packages of paper until necessary so that the paper does not absorb too much moisture. • If background scatter occurs on an envelope, change the printing layout to avoid printing over areas that have overlapping seams on the reverse side. Printing on seams can cause problems. • If background scatter covers the entire surface area of a printed page, adjust the print resolution through your software application or the printer properties.

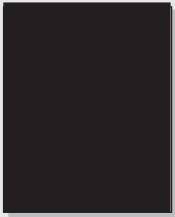
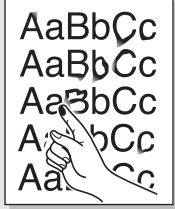
CONDITION	SUGGESTED SOLUTIONS
Misformed characters 	<ul style="list-style-type: none"> • If characters are improperly formed and producing hollow images, the paper stock may be too slick. Try a different paper. See page 33. • If characters are improperly formed and producing a wavy effect, the scanner unit may need service. For service, contact a service representative.
Page skew 	<ul style="list-style-type: none"> • Ensure that the paper is loaded properly. • Check the paper type and quality. See page 33. • Ensure that the paper or other material is loaded correctly and the guides are not too tight or too loose against the paper stack.
Curl or wave 	<ul style="list-style-type: none"> • Ensure that the paper is loaded properly. • Check the paper type and quality. Both high temperature and humidity can cause paper curl. See page 33. • Turn over the stack of paper in the tray. Also try rotating the paper 180° in the tray.
Wrinkles or creases 	<ul style="list-style-type: none"> • Ensure that the paper is loaded properly. • Check the paper type and quality. See page 33. • Turn over the stack of paper in the tray. Also try rotating the paper 180° in the tray.
Back of printouts are dirty 	<ul style="list-style-type: none"> • Check for leaking toner. Clean the inside of the machine. See page 62.

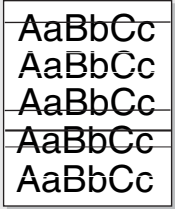
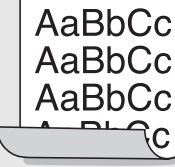
CONDITION	SUGGESTED SOLUTIONS
Solid Color or Black pages 	<ul style="list-style-type: none"> The toner cartridge may not be installed properly. Remove the cartridge and reinsert it. The toner cartridge may be defective and need replacing. Remove the toner cartridge and install a new one. See page 65. The machine may require repair. Contact a service representative.
Loose toner 	<ul style="list-style-type: none"> Clean the inside of the machine. See page 62. Check the paper type and quality. See page 33. Remove the toner cartridge and install a new one. See page 65. If the problem persists, the machine may require repair. Contact a service representative.
Character Voids 	<p>Character voids are white areas within parts of characters that should be solid black:</p> <ul style="list-style-type: none"> If you are using transparencies, try another type of transparency. Because of the composition of transparencies, some character voids are normal. You may be printing on the wrong surface of the paper. Remove the paper and turn it around. The paper may not meet paper specifications. See page 33.
Horizontal stripes 	<p>If horizontally aligned black streaks or smears appear:</p> <ul style="list-style-type: none"> The toner cartridge may be installed improperly. Remove the cartridge and reinsert it. The toner cartridge may be defective. Remove the toner cartridge and install a new one. See page 65. If the problem persists, the machine may require repair. Contact a service representative.
Curl 	<p>If the printed paper is curled or paper does not feed into the machine:</p> <ul style="list-style-type: none"> Turn over the stack of paper in the tray. Also try rotating the paper 180° in the tray. Change the printer option and try again. Go to printer properties, click Paper tab, and set type to Thin Paper. Refer to the <i>Software section</i> for details.
An unknown image repetitively appears on a next few sheets or loose toner, light print, or contamination occurs.	<p>Your printer is probably being used at an altitude of 1,000 m (3,281 ft) or above. The high altitude may affect the print quality such as loose toner or light imaging. You can set this option through Printer Settings Utility or Printer tab in printer driver's properties. See page 28.</p>

Copying problems

CONDITION	SUGGESTED SOLUTIONS
Copies are too light or too dark.	<p>Use Darkness to darken or lighten the background of the copies.</p>
Smears, lines, marks, or spots appears on copies.	<ul style="list-style-type: none"> If defects are on the original, press Darkness to lighten the background of your copies. If no defects are on the original, clean the scan unit. See page 64.
Copy image is skewed.	<ul style="list-style-type: none"> Ensure that the original is face down on the scanner glass or face up in the DADF (or ADF). Check that the copy paper is loaded correctly.
Blank copies print out.	<p>Ensure that the original is face down on the scanner glass or face up in the DADF (or ADF).</p>
Image rubs off the copy easily.	<ul style="list-style-type: none"> Replace the paper in the tray with paper from a new package. In high humidity areas, do not leave paper in the machine for extended periods of time.
Frequent copy paper jams occur.	<ul style="list-style-type: none"> Fan the stack of paper, then turn it over in the tray. Replace the paper in the tray with a fresh supply. Check/adjust the paper guides, if necessary. Ensure that the paper is the proper paper weight. 75 g/m² (20 lb bond) paper is recommended. Check for copy paper or pieces of copy paper remaining in the machine after a paper jam has been cleared.
Toner cartridge produces fewer copies than expected before running out of toner.	<ul style="list-style-type: none"> Your originals may contain pictures, solids, or heavy lines. For example, your originals may be forms, newsletters, books, or other documents that use more toner. The machine may be turned on and off frequently. The scanner lid may be left open while copies are being made.

Scanning problems

CONDITION	SUGGESTED SOLUTIONS
The scanner does not work.	<ul style="list-style-type: none"> • Make sure that you place the original to be scanned face down on the scanner glass, or face up in the DADF . • There may not be enough available memory to hold the document you want to scan. Try the Prescan function to see if that works. Try lowering the scan resolution rate. • Check that the USB cable is connected properly. • Make sure that the USB cable is not defective. Switch the cable with a known good cable. If necessary, replace the cable. • Check that the scanner is configured correctly. Check scan setting in the SmarThru Configuration or the application you want to use to make certain that the scanner job is being sent to the correct port.
The unit scans very slowly.	<ul style="list-style-type: none"> • Check if the machine is printing received data. If so, scan the document after the received data has been printed. • Graphics are scanned more slowly than text. • Communication speed slows in scan mode because of the large amount of memory required to analyze and reproduce the scanned image. Set your computer to the ECP printer mode through BIOS setting. It will help to increase the speed. For details about how to set BIOS, refer to your computer user's guide.
Message appears on your computer screen: <ul style="list-style-type: none"> • "Device can't be set to the H/W mode you want." • "Port is being used by another program." • "Port is Disabled." • "Scanner is busy receiving or printing data. When the current job is completed, try again." • "Invalid handle." • "Scanning has failed." 	<ul style="list-style-type: none"> • There may be a copying or printing job in progress. When that job is complete, try your job again. • The Selected port is currently being used. Restart your computer and try again. • The printer cable may be improperly connected or the power may be off. • The scanner driver is not installed or the operating environment is not set up properly. • Ensure that the machine is properly connected and the power is on, Then restart your computer. • The USB cable may be improperly connected or the power may be off.

Samsung Scan Manager problems

CONDITION	SUGGESTED SOLUTIONS
I cannot use the Scan Manager.	Check your operating system. Supporting operating systems are Windows 2000/XP/Vista.

Fax problems

CONDITION	SUGGESTED SOLUTIONS
The machine is not working, there is no display and the buttons are not working.	<ul style="list-style-type: none"> • Unplug the power cord and plug it in again. • Ensure that there is power to the electrical outlet.
No dial tone sounds.	<ul style="list-style-type: none"> • Check that the phone line is connected properly. • Check that the phone socket in the wall is working by plugging in another phone.
The numbers stored in memory do not dial correctly.	Make sure that the numbers are stored in memory correctly. Print a Phone Book list, referring to page 57.
The original does not feed into the machine.	<ul style="list-style-type: none"> • Make sure that the paper is not wrinkled and you are putting it in correctly. Check that the original is the right size, not too thick or thin • Make sure that the DADF is firmly closed. • The ADF rubber pad may need to be replaced. See page 68.
Faxes are not received automatically.	<ul style="list-style-type: none"> • The receiving mode should be set to Fax. • Make sure that there is paper in the tray. • Check to see if the display shows any error message. If it does, clear the problem.
The machine does not send.	<ul style="list-style-type: none"> • Make sure that the original is loaded in the DADF or on the scanner glass. • Sending should show up on the display. • Check the fax machine you are sending to, to see if it can receive your fax.
The incoming fax has blank spaces or is of poor-quality.	<ul style="list-style-type: none"> • The fax machine sending you the fax may be faulty. • A noisy phone line can cause line errors. • Check your machine by making a copy. • The toner cartridge may be empty. Replace the toner cartridge, referring to page 65.
Some of the words on an incoming fax are stretched.	The fax machine sending you the fax had a temporary document jam.
There are lines on the originals you send.	Check your scan unit for marks and clean it. See page 64.

CONDITION	SUGGESTED SOLUTIONS
The machine dials a number, but a connection with the other fax machine fails.	The other fax machine may be turned off, out of paper, or cannot answer incoming calls. Speak with the other machine operator and ask her/him to sort out the problem.
Faxes do not store in memory.	There may not be enough memory space to store the fax. If the display shows the Memory Full message, delete from memory any faxes you no longer need and then try again to store the fax.
Blank areas appear at the bottom of each page or on other pages, with a small strip of text at the top.	You may have chosen the wrong paper settings in the user option setting. For details about paper settings, see page 33.

Common PostScript problems

The following situations are PS language specific and may occur when several printer languages are being used.

-  To receive a printed or screen-displayed message when PostScript errors occur, open the Print Options window and click the desired selection next to the PostScript errors section

PROBLEM	POSSIBLE CAUSE	SOLUTION
PostScript file cannot be printed.	The PostScript driver may not be installed correctly.	<ul style="list-style-type: none"> Install the PostScript driver, referring to <i>Software section</i>. Print a configuration page and verify that the PS version is available for printing. If the problem persists, contact a service representative.
“Limit Check Error” message appears.	The print job was too complex.	You might need to reduce the complexity of the page or install more memory.
A PostScript error page prints.	The print job may not be PostScript.	Make sure that the print job is a PostScript job. Check to see whether the software application expected a setup or PostScript header file to be sent to the machine.
The optional tray is not selected in the driver.	The printer driver has not been configured to recognize the optional tray.	Open the PostScript driver properties, select the Device Settings tab, and set the Tray option of the Installable Options section to Installed .

PROBLEM	POSSIBLE CAUSE	SOLUTION
When printing a document in Macintosh with Acrobat Reader 6.0 or higher, colors print incorrectly.	The resolution setting in the printer driver may not be matched with the one in Acrobat Reader.	Make sure that the resolution setting in your printer driver matches the one in Acrobat Reader.

Common Windows problems

CONDITION	SUGGESTED SOLUTIONS
“File in Use” message appears during installation.	Exit all software applications. Remove all software from the StartUp Group, then restart Windows. Reinstall the printer driver.
“General Protection Fault”, “Exception OE”, “Spool32”, or “Illegal Operation” messages appear.	Close all other applications, reboot Windows and try printing again.
“Fail To Print”, “A printer timeout error occurred.” messages appear.	These messages may appear during printing. Just keep waiting until the machine finishes printing. If the message appears in ready mode or after printing has been completed, check the connection and/or whether an error has occurred.

-  Refer to the Microsoft Windows documentation that came with your computer for further information on Windows error messages.

Common Linux problems

CONDITION	SUGGESTED SOLUTIONS
The machine does not print.	<ul style="list-style-type: none"> • Check if the printer driver is installed in your system. Open Unified Driver configurator and switch to the Printers tab in Printers configuration window to look at the list of available printers. Make sure that your machine is displayed on the list. If not, invoke Add new printer wizard to set up your device. • Check if the printer is started. Open Printers configuration and select your machine on the printers list. Look at the description in the Selected printer pane. If its status contains “(stopped)” string, press the Start button. After that normal operation of the printer should be restored. The “stopped” status might be activated when some problems in printing occurred. For instance, this could be an attempt to print document when port is claimed by a scanning application. • Check if the port is not busy. Since functional components of MFP (printer and scanner) share the same I/O interface (port), the situation of simultaneous access of different “consumer” application to the same port is possible. To avoid possible conflicts, only one of them at a time is allowed to gain control over the device. The other “consumer” will encounter “device busy” response. You should open ports configuration and select the port assigned to your printer. In the Selected port pane you can see if the port is occupied by some other application. If this is the case, you should wait for completion of the current job or should press Release port button, if you are sure that the present owner is not functioning properly. • Check if your application has special print option such as “-oraw”. If “-oraw” is specified in the command line parameter then remove it to print properly. For Gimp front-end, select “print” -> “Setup printer” and edit command line parameter in the command item. • The CUPS (Common Unix Printing System) version distributed with SuSE Linux 9.2 (cups-1.1.21) has a problem with ipp (Internet Printing Protocol) printing. Use the socket printing instead of ipp or install later version of CUPS (cups-1.1.22 or higher).
Some color images come out all black.	<p>This is a known bug in Ghostscript (until GNU Ghostscript version 7.05) when the base color space of the document is indexed color space and it is converted through CIE color space. Because Postscript uses CIE color space for Color Matching System, you should upgrade Ghostscript on your system to at least GNU Ghostscript version 7.06 or later. You can find recent Ghostscript versions at www.ghostscript.com.</p>

CONDITION	SUGGESTED SOLUTIONS
Some color images come out in unexpected color.	<p>This is a known bug in Ghostscript (until GNU Ghostscript version 7.xx) when the base color space of the document is indexed RGB color space and it is converted through CIE color space. Because Postscript uses CIE color space for Color Matching System, you should upgrade Ghostscript on your system to at least GNU Ghostscript version 8.xx or later. You can find recent Ghostscript versions at www.ghostscript.com.</p>
The machine does not print whole pages and its output is half page printed.	<p>It is a known problem that occurs when a color printer is used on version 8.51 or earlier of Ghostscript, 64-bit Linux OS, and reported to bugs.ghostscript.com as Ghostscript Bug 688252.</p> <p>The problem is solved in AFPL Ghostscript v. 8.52 or above. Download the latest version of AFPL Ghostscript from http://sourceforge.net/projects/ghostscript/ and install it to solve this problem.</p>
I cannot scan via Gimp Front-end.	<ul style="list-style-type: none"> • Check if Gimp Front-end has “Xsane: Device dialog.” on the “Acquire” menu. If not, you should install Xsane plug-in for Gimp on the your computer. You can find Xsane plug-in package for Gimp on Linux distribution CD or Gimp home page. For the detail information, refer to the Help for Linux distribution CD or Gimp Front-end application. <p>If you wish to use other kind of scan application, refer to the Help for application.</p>
I encounter error “Cannot open port device file” when printing a document.	<p>Avoid changing print job parameters (via LPR GUI, for example) while a print job is in progress. Known versions of CUPS server break the print job whenever print options are changed and then try to restart the job from the beginning. Since Unified Linux Driver locks port while printing, the abrupt termination of the driver keeps the port locked and therefore unavailable for subsequent print jobs. If this situation occurred, try to release the port.</p>

CONDITION	SUGGESTED SOLUTIONS
<p>The machine does not appear on the scanners list.</p>	<ul style="list-style-type: none"> • Check if your machine is attached to your computer. Make sure that it is connected properly via the USB port and is turned on. • Check if the scanner driver for your machine is installed in your system. Open Unified Driver configurator, switch to Scanners configuration, then press Drivers. Make sure that driver with a name corresponding to your machine's name is listed in the window. Check if the port is not busy. Since functional components of MFP (printer and scanner) share the same I/O interface (port), the situation of simultaneous access of different “consumer” application to the same port is possible. To avoid possible conflicts, only one of them at a time is allowed to gain control over the device. The other “consumer” will encounter “device busy” response. This can usually happen while starting scan procedure, and appropriate message box appears. • To identify the source of the problem, you should open ports configuration and select the port assigned to your scanner. port's symbol /dev/mfp0 corresponds to LP:0 designation displayed in the scanners' options, /dev/mfp1 relates to LP:1 and so on. USB ports start at /dev/mfp4, so scanner on USB:0 relates to /dev/mfp4 respectively and so forth sequentially. In the Selected port pane you can see if the port is occupied by some other application. If this is the case, you should wait for completion of the current job or should press Release port button, if you are sure that the present port's owner is not functioning properly.

CONDITION	SUGGESTED SOLUTIONS
<p>The machine does not scan.</p>	<ul style="list-style-type: none"> • Check if a document is loaded into the machine. • Check if your machine is connected to the computer. Make sure if it is connected properly if I/O error is reported while scanning. • Check if the port is not busy. Since functional components of MFP (printer and scanner) share the same I/O interface (port), the situation of simultaneous access of different “consumer” application to the same port is possible. To avoid possible conflicts, only one of them at a time is allowed to gain control over the device. The other “consumer” will encounter “device busy” response. This can usually happen while starting scan procedure, and appropriate message box will be displayed. To identify the source of the problem, you should open ports configuration and select the port assigned to your scanner. port's symbol /dev/mfp0 corresponds to LP:0 designation displayed in the scanners' options, /dev/mfp1 relates to LP:1 and so on. USB ports start at /dev/mfp4, so scanner on USB:0 relates to /dev/mfp4 respectively and so forth sequentially. In the Selected port pane you can see if the port is occupied by some other application. If this is the case, you should wait for completion of the current job or should press Release port button, if you are sure that the present port's owner is not functioning properly.

 Refer to Linux User's Guide that came with your computer for further information on Linux error messages.

Common Macintosh problems

CONDITION	SUGGESTED SOLUTIONS
The printer does not print PDF file correctly. Some parts of graphics, text, or illustrations are missing.	<p>Incompatibility between the PDF file and the Acrobat products: Printing the PDF file as an image may solve this problem. Turn on Print As Image from the Acrobat printing options.</p> <p> It will take longer to print when you print a PDF file as an image.</p>
The document has printed, but the print job has not disappeared from the spooler in Mac OS 10.3.2.	<p>Update your Mac OS to OS 10.3.3. or higher.</p>
Some letters are not displayed normally during the Cover page printing.	<p>This problem is caused because Mac OS cannot create the font during the Cover page printing. English alphabet and numbers are displayed normally at the Cover page.</p>

 Refer to Mac OS User's Guide that came with your computer for further information on Mac OS error messages.

ordering supplies and accessories

This chapter provides information on purchasing cartridges and accessories available for your machine.

This chapter includes:

- Supplies
- Accessories

 The optional parts or features may differ by countries. Contact your sales representatives whether the part you want is available in your country.

SUPPLIES

When the toner runs out, you can order the following type of toner cartridge for your machine:

TYPE	AVERAGE YIELD ^a	PART NUMBER
High yield toner cartridge	<ul style="list-style-type: none">• Average continuous black cartridge yield: 5,500 standard pages (Black)• Average continuous colored cartridge yield: 5,000 standard pages (Yellow/Magenta/Cyan)	DKT2500K (Black) DKT2500C (Cyan) DKT2500M (Magenta) DKT2500Y (Yellow)
Paper transfer belt	Approx. 50,000 When the transfer belt has worn out with abrasion, you need to change it. By this time you may be notified with the transfer belt-related message on the display.	PTB2500

a. Declared yield value in accordance with ISO/IEC 19798.



- How to purchase

ACCESSORIES

You can purchase and install accessories to enhance your machine's performance and capacity.

ACCESSORY	DESCRIPTION	PART NUMBER
Memory module	Extends your machine's memory capacity.	
Optional tray 2	If you are experiencing frequent paper supply problems, you can attach an additional 500 sheet tray. You can print documents in various sizes and types of print materials.	C2500CAS

a. Depending on your country, wireless LAN cards may not be available. Contact your local Samsung dealer or the retailer where you bought your printer.

 Your machine may have two memory slots with a factory pre-installed memory module in one slot. When you are expanding the memory capacity, you can add a memory module to the vacant memory slot, according to the table above. It is strongly recommended that you expand a memory module in vacant memory slot only, without removing a pre-installed memory module. If your machine has 128 MB memory capacity and you want to add 512 MB, the memory capacity expands up to 640 MB.

installing accessories

This chapter includes:

- Precautions to take when installing accessories
- Upgrading a memory module

PRECAUTIONS TO TAKE WHEN INSTALLING ACCESSORIES

- Disconnect the power cord
Never remove the control board cover while the power is turned on. To avoid the possibility of an electrical shock, always disconnect the power cord when installing or removing ANY internal or external accessories.
- Discharge static electricity
The control board and internal accessories (network interface card or memory module) are sensitive to static electricity. Before installing or removing any internal accessories, discharge static electricity from your body by touching something metal, such as the metal back plate on any device plugged into a grounded power source. If you walk around before finishing the installation, repeat this procedure to discharge any static electricity again.

 When installing accessories, battery inside the machine is a service component. Do not change it by yourself. Risk of explosion if battery is replaced by an incorrect type. Dispose used batteries according to the instructions.

UPGRADING A MEMORY MODULE

Your machine has a dual in-line memory module (DIMM). Use this memory module slot to install additional memory.

The machine has two memory slots with a factory pre-installed memory module in one slot. When you are expanding the memory capacity, you can add a memory module to the vacant memory slot. It is strongly recommended that you expand a memory module in vacant memory slot only without removing a pre-installed memory module. If your machine has 128 MB memory capacity and you want to add 512 MB, the memory capacity expands up to 640 MB. Order information is provided for optional memory module. (See page 90)

Installing a memory module

1. Turn the machine off and unplug all cables from the machine.

- Using a wireless network interface card
- Using the hard disk

2. Release the screws and remove the rear cover.

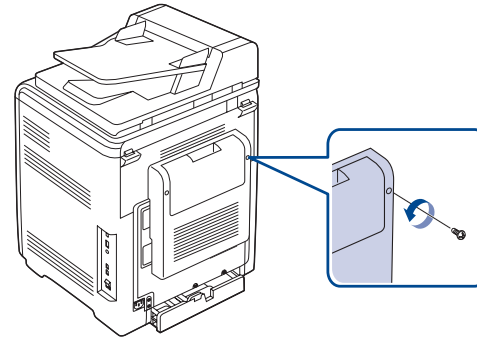

3. Release the screws, then lift up the cover slightly and pull the cover to the right.

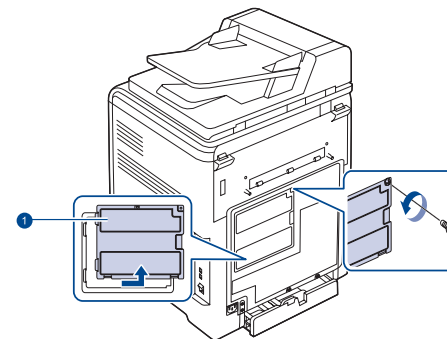



1 Control board cover

 If you want to remove an existing memory module, push the two latches at the ends of the module outward.

4. Take out a new memory module from the plastic bag.

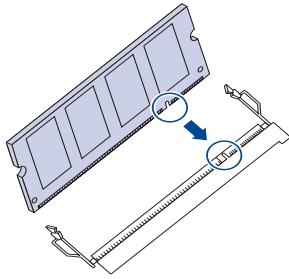
5. Holding the memory module by the edges, align the memory module on the slot at about a 30-degree tilt. Make sure that the notches of the module and the grooves on the slot fit each other.



 The notches and grooves illustrated above may not match those on an actual memory module and its slot.

6. Press the memory module into the slot with care until you hear a 'click'.

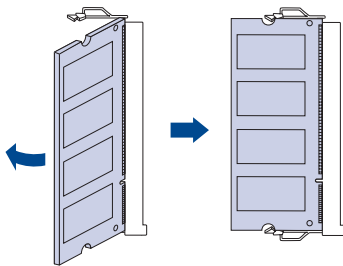

 Do not press the memory module strongly or the module may be damaged. If the module does not seem to fit into the slot properly, carefully try the previous procedure again.

7. Replace the control board cover and fasten the cover with the screws.

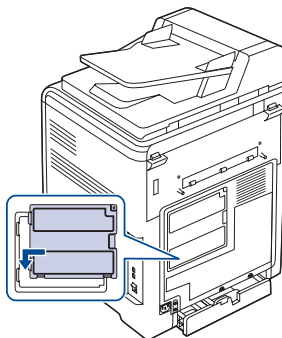

8. Replace the rear cover and fasten the cover with the screw.
9. Reconnect the power cord and printer cable, and turn the machine on.

 To release the memory module, pull the two tabs on the sides of the slot outwards, then the module springs out.

Activating the added memory in the PS printer properties

After installing the memory module, you need to select it in the printer properties of the PostScript printer driver in order to use it.

1. Make sure that the PostScript printer driver is installed on your computer. For details about installing the PS printer driver, see *Software section*.
2. Click the Windows **Start** menu.
3. For Windows 2000, select **Settings** and then **Printers**.
For Windows XP/2003, select **Printers and Faxes**.
For Windows Vista, select **Control Panel > Hardware and Sound > Printers**.
4. Select the **CLX-6200 Series PS** or **Samsung CLX-6240 Series PS** printer.
5. Click the right mouse button on the printer icon and select **Properties**.
6. For Windows 2000/XP/2003/Vista, select **Device Settings**.
7. Select the amount of memory you installed from **Printer Memory** in the **Installable Options** section.
8. Click **OK**.

USING A WIRELESS NETWORK INTERFACE CARD

The MFX-C2500 is equipped with a network interface which allows you to use your machine on a network. You can also purchase a wireless network interface card to enable the use of the printer in wireless network environments. For order information, see page 90. Review the precautions on page 92 and then follow this procedure to install the wireless network interface card in your machine.

Installing a wireless network interface card

1. Turn the machine off and unplug all cables from the machine.
2. Release the screws and remove the rear cover.

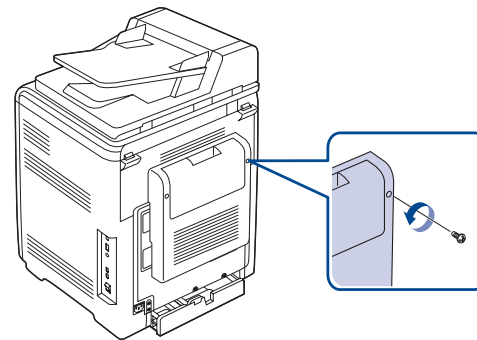

3. Release the screws, then lift up the cover slightly and pull the cover to the right.

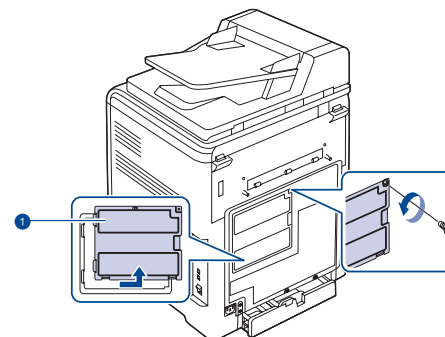

1 Control board cover

- Align the connector on the wireless network interface card with the connector on the control board. Push the card firmly into the connector on the control board until it is completely and securely in place.

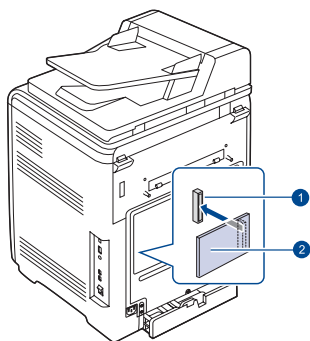

-
- Connector
 - Wireless network interface card
-

- Replace the control board cover and fasten the cover with the screws.

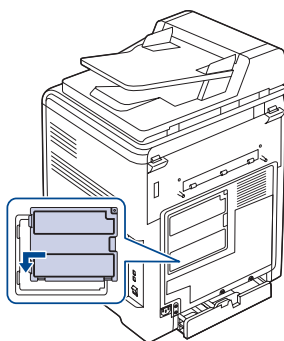

- Replace the rear cover and fasten the cover with the screw.
- Reconnect the power cord and printer cable, and turn the machine on.

-  For information about configuring and using the printer on a wireless network environment, refer to the user's guide provided with the wireless network interface card. You can also configure the network parameters on the control panel; see the next column.

Configuring basic network settings

After installing the wireless network card, you must configure the appropriate network parameters to use your printer in a wireless network. To do this, you can use both control panel and SyncThru Web Service, an embedded web site of your printer. This section gives you basic information on 802.11b/g network parameters which can be configured from the control panel.

You can configure basic wireless settings, such as SSID, Operation Mode, and channels. You can retrieve basic settings by selecting a wireless network or manually configure them as you need.

- Press **Menu** until **Network** appears on the bottom line of the display and press **OK**.
- Press the left/right arrow until **Wireless** appears and press **OK**.
- Press **OK** when **WLAN Basic** appears.
- Press the left/right arrow to select the setup method you want and press **OK**.
 - Search List:** The wireless network interface card on your printer searches for wireless networks in the area and shows the results.
 - Custom:** You can configure the wireless settings according to your needs.

- If you selected **Search List**, press the left/right arrow to select a network and press **OK**.

If you selected **Custom**, set each network options:

- Edit SSID:** Enter the SSID, the name that identifies a wireless network. SSID is case-sensitive so you need to enter it.
- Operation Mode:** Select the type of wireless connections. In **Ad-Hoc** mode, wireless cards communicate directly each other. In **Infrastructure** mode, network cards communicate with each other through an access point, which allows both wireless and cabled cards to send files to the printer.

 In **Ad-Hoc** mode, even if the network cable is connected, your printer will use the wireless interface.

- Channel:** This option is available only in the Ad-Hoc mode. In most cases, you will not need to change this setting. The printer will scan all available channels for the specified network and will adapt its channel to the one detected.

- When you have finished, press **Stop/Clear** to return to ready mode.

Selecting the authentication type

Authentication is a process of identifying the legitimacy of an user to access a network. You can select whether or not authentication is used.

- Press **Menu** until **Network** appears on the bottom line of the display and press **OK**.
- Press the left/right arrow until **Wireless** appears and press **OK**.
- Press the left/right arrow until **WLAN Security** appears and press **OK**.
- Press the left/right arrow until **Static WEP** appears and press **OK**.
- Press the left/right arrow until **Authentication** appears and press **OK**.
- Press the left/right arrow to select the type you want.
 - Open System:** Authentication is not used.
 - Shared Key:** Authentication is used.
- Press **OK** to save your selection.
- Press **Stop/Clear** to return to ready mode.

Setting Encryption

If your network uses WEP encryption keys, you can must select the appropriate encryption type and configure encryption keys. You can configure up to four keys. The active key must match the key value and key position (for example, Key 1) configured on other wireless devices in the network.

- Press **Menu** until **Network** appears on the bottom line of the display and press **OK**.
- Press the left/right arrow until **Wireless** appears and press **OK**.
- Press the left/right arrow until **WLAN Security** appears and press **OK**.
- Press the left/right arrow until **Static WEP** appears and press **OK**.
- Press the left/right arrow until **Encryption** appears and press **OK**.

 If you have set the authentication type to **Open System**, the **Encryption** menu does not display.
- Set each encryption option and press **OK**.
 - Encrypt. Type:** Select an encryption type: **None**, **64-bit WEP**, or **128-bit WEP**.
 - Key Type:** Select the key type of your network.
 - Using Key:** Select the key to be used in your network.
 - Edit Key:** Enter the key number for the selected key position.

The numbers you can enter as follows:

	HEXADECIMAL	ALPHANUMERIC
64-bit WEP	10 digits	5 characters
128-bit WEP	26 digits	13 characters

- When you have finished, press **Stop/Clear** to return to ready mode.

Restoring default values for wireless networking

If the problem occurs when you use or set up the wireless network values, take following steps to restore factory default values. Generally, factory values of wireless networking are optimized for your printer.

- Press **Menu** until **Network** appears on the bottom line of the display and press **OK**.
- Press the left/right arrow until **Wireless** appears and press **OK**.
- Press the left/right arrow until **WLAN Default** appears and press **OK**.
- When **Restore** appears on the bottom line of the display, press **OK**. The machine starts restoring the default values.

USING THE HARD DISK

Installing the hard disk allows the data from your computer to be sent to the print queue of the printer hard disk. This decreases the workload of the computer. You can also use various print features, such as storing a job in the hard disk, proofing a job, and printing private documents.

Installing the hard disk

For order information, see "Accessories" on page 90. Review the precautions on page 92.

- Turn the machine off and unplug all cables from the machine.
- Release the screws and remove the rear cover.

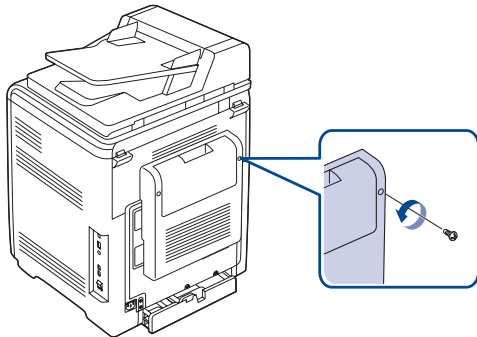

- Open the control board cover. Release the screws, then lift up the cover slightly and pull the cover to the right.

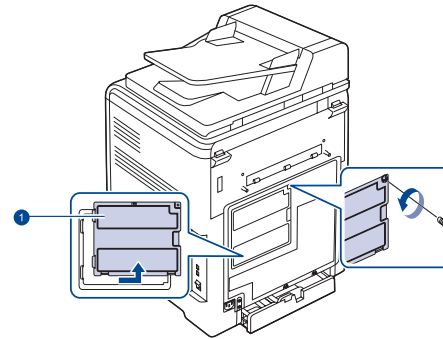

- Align the connector on the hard disk with the connector on the control board. Push the hard disk in until it is latched into place.

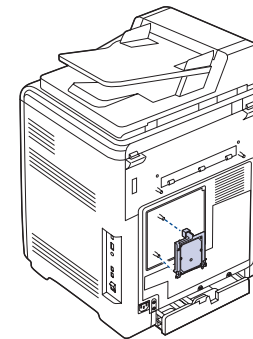

- Fasten the screws supplied with your new hard disk.

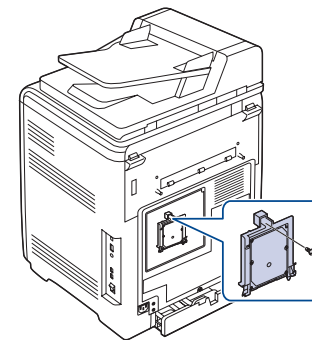

- Replace the control board cover and fasten the cover with the screws.

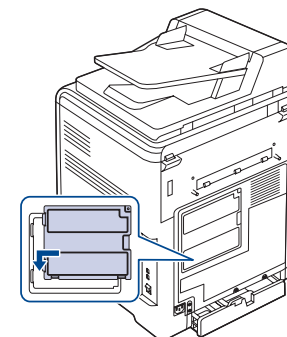

- Replace the rear cover and fasten the cover with the screw.

8. Reconnect the power cord and printer cable, and turn the machine on.
9. Print a configuration page from the control panel to check if the hard disk is correctly installed. See page 61.

Setting the hard disk in the printer properties

After installing the hard disk, you need to select it in the printer properties to enable its use. Take the following steps:

1. Click the Windows **Start** menu.
2. For Windows 2000, select **Settings** and then **Printers**.
For Windows XP/2003, select **Printers and Faxes**.
For Windows Vista, select **Control Panel > Hardware and Sound > Printers**.
3. Select the CLX-6200 Series or CLX-6240 Series printer icon or CLX-6200 Series PS or CLX-6240 Series PS printer icon.
4. Right-click on the printer icon and select **Properties**.
 - **CLX-6200 Series or CLX-6240 Series:** Click the **Printer** tab and then check **Optional Hard Disk Drive (HDD)**.
 - **CLX-6200 Series PS or CLX-6240 Series PS:** Click the **Device Option** or **Device Settings** tab and set the **Optional Hard Disk Drive (HDD)** option to **Installed**
5. Click **OK**.

Printing with the optional hard disk

After installing the optional hard disk, you can use advanced printing features, such as storing or spooling a print job to the hard disk, proofing a job, and specifying of printing a private job in the printer properties window.

Once you have stored files in the hard disk, you can easily print or delete the stored files using the control panel of your printer.

Storing a job

You can store jobs in the installed hard disk.

1. Open the file you want to store.
2. Select **Print** from the **File** menu. The Print window displays.
3. Click **Properties**. If you see **Setup**, **Print** or **Options**, click the button instead.
4. Click the **Extra** tab and click **Job Setting**.
5. Select the print mode you want from the drop-down list.
 - **Normal:** Prints in normal mode.
 - **Proof:** Prints the first file and after a pause prints the next file.
 - **Confidential:** Stores the files, securing them with a password.
 - **Store:** Stores the file to the hard disk.
 - **Spool:** Spools the file into the hard disk and prints it from the hard disk queue.
 - **Delay:** Prints the file at a specified time.
6. Enter the user's name and file name.
7. Click **OK** until the Print window is displayed.
8. Click **OK** or **Print** to start printing.

Printing a stored job

You can print jobs currently stored in the hard disk.

1. Press **Menu** until **System Setup** appears on the bottom line of the display and press **OK**.
2. Press the left/right arrow until **Job Manage** appears and press **OK**.
3. Press the left/right arrow until **Store Job** appears and press **OK**.
4. Press the left/right arrow until the user's name and file name you want appear and press **OK**.

5. If the select file is a confidential print job, enter the specified 4-digit password.
Press the left/right arrow to enter the first digit and press **OK**. The cursor automatically moves to the next digit position. Enter the 2nd, 3rd, and 4th digit in the same way.
6. When **Print** appears, press **OK**.
If you enter the incorrect password, **Invalid Password** appears. Reenter the correct password.
7. Press the left/right arrow until the number of copies you want appears and press **OK**.
8. Press **OK**. Printing starts.

Deleting a stored job

You can delete jobs currently stored in the hard disk.

1. Press **Menu** until **System Setup** appears on the bottom line of the display and press **OK**.
2. Press the left/right arrow until **Job Manage** appears and press **OK**.
3. Press the left/right arrow until **Store Job** appears and press **OK**.
4. Press the left/right arrow until the user's name and file name you want appear and press **OK**.
5. If the select file is a confidential print job, enter the specified 4-digit password.
Press the left/right arrow to enter the first digit and press **OK**. The cursor automatically moves to the next digit position. Enter the 2nd, 3rd, and 4th digit in the same way.
6. Press the left/right arrow until **Delete** appears and press **OK**.
If you enter the incorrect password, **Invalid Password** appears. Reenter the correct password.
7. When **Yes** appears, press **OK**.

Controlling the active job queue

All of the print jobs waiting to be printed are listed in the Active Job Queue in the order you sent them to the printer. You can delete a job from the queue before printing, or promote a job to print sooner.

To delete a file from the queue:

1. Press **Menu** until **System Setup** appears on the bottom line of the display and press **OK**.
2. Press the left/right arrow until **Job Manage** appears and press **OK**.
3. Press the left/right arrow until **Active Job** appears and press **OK**.
4. Press the left/right arrow until the user's name and file name you want appear and press **OK**.
5. If the select file is a confidential print job, enter the specified 4-digit password.
Press the left/right arrow to enter the first digit and press **OK**. The cursor automatically moves to the next digit position. Enter the 2nd, 3rd, and 4th digit in the same way.
6. Press the left/right arrow until **Cancel** appears and press **OK**.
If you enter the incorrect password, **Invalid Password** appears. Reenter the correct password.
7. Press the left/right arrow until **Yes** appears and press **OK**.

To promote a file from the queue:

You can select a job waiting in the Active Job Queue and change its print order so that it can be printed sooner.

1. Press **Menu** until **System Setup** appears on the bottom line of the display and press **OK**.
2. Press the left/right arrow until **Job Manage** appears and press **OK**.
3. Press the left/right arrow until **Active Job** appears and press **OK**.

4. Press the left/right arrow until the user's name and file name you want appear and press **OK**.
5. If the select file is a confidential print job, enter the specified 4-digit password.
Press the left/right arrow to enter the first digit and press **OK**. The cursor automatically moves to the next digit position. Enter the 2nd, 3rd, and 4th digit in the same way.
6. Press the left/right arrow until **Promote** appears and press **OK**.
If you enter the incorrect password, **Invalid Password** appears. Reenter the correct password.

To print a file immediately:

You can print a job scheduled to be printed at a specified time immediately. In this case, the job currently printing is stopped and the selected job will be printed. This function is available when the job is scheduled for later printing.

1. Press **Menu** until **System Setup** appears on the bottom line of the display and press **OK**.
2. Press the left/right arrow until **Job Manage** appears and press **OK**.
3. Press the left/right arrow until **Active Job** appears and press **OK**.
4. Press the left/right arrow until the user's name and file name you want appear and press **OK**.
5. If the select file is a confidential print job, enter the specified 4-digit password.
Press the left/right arrow to enter the first digit and press **OK**. The cursor automatically moves to the next digit position. Enter the 2nd, 3rd, and 4th digit in the same way.
6. Press the left/right arrow until **Release** appears and press **OK**.
This option appears only when you select a **Delay** print job. See page 96.
If you enter the incorrect password, **Invalid Password** appears. Reenter the correct password.

Printing using the form files

You can store up to 10 form files in the hard disk and make them printed with your document.

First, you need to create a form file using the printer driver. See the *Software section*.

1. Press **Menu** until **System Setup** appears on the bottom line of the display and press **OK**.
2. Press the left/right arrow until **Form Menu** appears and press **OK**.
3. Press the left/right arrow until the form you want appears and press **OK**.
 - **Off**: Prints in normal mode.
 - **Single Form**: Prints all page using the first form.
 - **Double Form**: Prints the front page using the first form and the back page using the second form.
4. Press **Back** to return to the upper menu level.
5. Press the left/right arrow until **Select Form** appears and press **OK**.
6. Press **OK** when **1st Form** appears.
7. Press the left/right arrow until the form file you want appears and press **OK**.
If you select **Double Form**, continue the next step.
8. Press the left/right arrow until **2nd Form** appears and press **OK**.
9. Press the left/right arrow until the form file for the second form appears and press **OK**.

File Policy

You can choose the file policy for generating file name before you proceed with the job through HDD. If the HDD memory already has the same name when you entered a new file name, you can rename or overwrite it.

1. Press **Menu** until **System Setup** appears on the bottom line of the display and press **OK**.
2. Press the left/right arrow until **Job Manage** appears and press **OK**.
3. Press the left/right arrow until **File Policy** appears and press **OK**.
4. Press the left/right arrow until the job setting you want appears and press **OK**.
 - **Rename**: If the HDD memory already has the same name when you enter a new file name, the file will be saved as a different name that is automatically programmed.
 - **Overwrite**: You can set the machine to delete previous job information on HDD as you store new job information.
5. Press **OK**.

Deleting residual image data

ImageOverwrite is a security measure for customers who are concerned about unauthorized access and duplication of classified or private document.

1. Press **Menu** until **System Setup** appears on the bottom line of the display and press **OK**.
2. Press the left/right arrow until **ImageOverwrite** appears and press **OK**.
3. Press the left/right arrow until the job setting you want appears and press **OK**.
 - **Immediate**: All residual image data from the machine will be erased immediately after each job has been processed.
 - **On Demand**: This option provides an on-demand facility for a system administrator to erase all the real image data remained in HDD after this option enabled. All existing jobs will be deleted regardless of their status and all job submissions will be prohibited for the duration of the overwrite.
4. Press the left/right arrow to move to **On** or **Off** for **Immediate**.
Press the left/right arrow to move to **Enable** or **Disable** for **On Demand**.
 - ✎ If you selected **On Demand** enabled, the machine confirms if the overwrite feature starts now. Press the left/right arrow to select **Yes** or **No**. If you select **Yes**, **On Demand** overwrite starts as soon as you select **Yes**. If you select **No**, this feature will be enabled.
5. Press **OK**.

specifications

This chapter guides you about this machine's specifications such as various features.

This chapter include:

- General specifications
- Printer specifications
- Scanner specifications
- Copier specifications
- Facsimile specifications

GENERAL SPECIFICATIONS

 The symbol * optional feature depending on machines.

ITEM	DESCRIPTION
DADF Capacity^a	Up to 50 sheets 75 g/m ² (20 lb bond)
DADF document size	<ul style="list-style-type: none"> • DADF Width: 148 to 216 mm/Length: 148 to 356 mm • ADF Width: 142 to 216 mm/Length: 148 to 356 mm
Paper input capacity	<ul style="list-style-type: none"> • Tray: 250 sheets for plain paper, 75 g/m² (20 lb bond) • Multi-purpose tray: 100 sheets for plain paper, 75 g/m² (20 lb bond) • Optional tray: 500 sheets for plain paper, 75 g/m² (20 lb bond) For details about paper input capacity, see 34 page.
Paper output capacity	Face down: 170 sheets 75 g/m ² (20 lb bond)
Power rating	AC 110 - 127 V or AC 220 - 240 V See the Rating label on the machine for the correct voltage, frequency (hertz) and type of current for your machine.
Power consumption	<ul style="list-style-type: none"> • Average operating mode: Less than 650 W • Ready mode: Less than 82 W • Power save mode: Less than 28 W • Power off mode: 0 W
Noise Level^b	<ul style="list-style-type: none"> • Ready mode: Less than 32 dBA • Printing mode: Less than 54 dBA • Copying mode: Less than 55 dBA
Default time to power save mode from ready mode	20 Minutes

ITEM	DESCRIPTION				
Boot-up time	<ul style="list-style-type: none"> • Less than 49 seconds • Less than 65 seconds The boot-up time will be longer, if data volume is a lot in the HDD				
Operating environment	<ul style="list-style-type: none"> • Temperature: 15 to 32.5 °C (59 to 90.5 °F) • Humidity: 20 to 80% RH 				
Display	16 characters x 2 lines				
Toner cartridge life^c	<table border="1"> <tr> <td>Black</td> <td>Average continuous black cartridge yield: 5,500 standard pages</td> </tr> <tr> <td>Color (Yellow/Magenta/Cyan)</td> <td>Average continuous colored cartridge yield: 5,000 standard pages</td> </tr> </table>	Black	Average continuous black cartridge yield: 5,500 standard pages	Color (Yellow/Magenta/Cyan)	Average continuous colored cartridge yield: 5,000 standard pages
Black	Average continuous black cartridge yield: 5,500 standard pages				
Color (Yellow/Magenta/Cyan)	Average continuous colored cartridge yield: 5,000 standard pages				
Paper transfer belt	Approx. 50,000 pages (A4, Letter)				
Memory (Expandable)*	<ul style="list-style-type: none"> • 256 MB (max. 768 MB) 				
External dimension (W x D x H)	468 x 498 x 651 mm (18.4 x 19.6 x 25.6 inches) without optional tray				
Weight (Including consumables)	<ul style="list-style-type: none"> • 37kg (81.57 lbs) 				
Package weight	<ul style="list-style-type: none"> • Paper: 5.8 Kg (12.7 lbs) • Plastic: 1.8 Kg (3.9 lbs) 				
Duty cycle (Monthly)	<ul style="list-style-type: none"> • Up to 80,000 pages 				
Fusing temperature	180 °C (356 °F)				

b. Sound Pressure Level, ISO 7779

c. Declared yield value in accordance with ISO/IEC 19798. The number of pages may be affected by operating environment, printing interval, media type, and media size.

PRINTER SPECIFICATIONS

ITEM	DESCRIPTION	
Printing method	Color laser beam printing	
Printing speed^a	Up to 24 ppm(A4), 25 ppm (Letter)	
Duplex printing speed	<ul style="list-style-type: none"> Up to 10 ipm (A4/Letter) 	
First print out time	Black & White	<ul style="list-style-type: none"> From ready: Less than 19 seconds From coldboot: Less than 80 seconds
	Color	<ul style="list-style-type: none"> From ready: Less than 19 seconds From coldboot: Less than 80 seconds
Print resolution	Max. 2,400 x 600 dpi effective output	
Printer language	PostScript 3, PCL6	
OS compatibility	<ul style="list-style-type: none"> Windows: 2000/XP/2003/Vista Linux: RedHat 8.0~9.0, Mandrake 9.2~10.1, SuSE 8.2~9.2, Fedora Core 1~4 Macintosh: Mac OS X 10.3~10.5, Universal Mac 	
Interface	<ul style="list-style-type: none"> High speed USB 2.0 Ethernet 10/100 Base TX (embedded type) 	

a. It will be affected by operating system used, computing performance, application software, connecting method, media type, media size and job complexity.

SCANNER SPECIFICATIONS

ITEM	DESCRIPTION	
Compatibility	TWAIN standard/WIA standard	
Scanning method	Color CCD	
Resolution^a	TWAIN standard/WIA standard	<ul style="list-style-type: none"> Optical: Up to 600 x 1,200 dpi Enhanced: Up to 4,800 x 4,800 dpi
	Scan to USB	100, 200, 300 dpi
	Scan to E-mail	100, 200, 300 dpi
	Scan to PC	75, 150, 200, 300, 600 dpi
Network Scan File format	PDF, TIFF, JPEG ^b , BMP	
Effective scanning length	<ul style="list-style-type: none"> Scanner glass: 289 mm (11.38 inches) DADF: 348 mm (13.7 inches) 	
Effective scanning width	Max. 208 mm (8.2 inches)	
Color bit depth	<ul style="list-style-type: none"> Internal: 36 bit External: 24 bit 	
Mono bit depth	<ul style="list-style-type: none"> 1 bit for black & white mode 8 bit for gray scale 	

a. Due to the applications for scanning, the maximum resolution might differ.

b. JPEG is not available when you select the mono mode in scan color.

COPIER SPECIFICATIONS

ITEM	DESCRIPTION	
Copy Speed^a	<ul style="list-style-type: none"> Up to 24 cpm(A4), 25 cpm (Letter) 	
Copy resolution	Text	<ul style="list-style-type: none"> DADF: Up to 600 x 600 dpi Scanner glass: Up to 600 x 600 dpi
	Text/photo	Up to 600 x 600 dpi
	Magazine	Up to 600 x 600 dpi
	Photo	<ul style="list-style-type: none"> DADF: Up to 600 x 600 dpi Scanner glass: Up to 1,200 x 1,200 dpi
Zoom range	<ul style="list-style-type: none"> DADF: 25% to 100% Scanner glass: 25% to 400% 	

a. Copy speed is based on Single Document Multiple Copy.

FACSIMILE SPECIFICATIONS



ITEM	DESCRIPTION	
Compatibility	ITU-T G3	
Applicable line	Public Switched Telephone Network (PSTN) or behind PABX	
Data coding	MH/MR/MMR/JBIG/JPEG	
Modem speed	33.6 Kbps	
Transmission speed	Up to 3 seconds/page ^a	
Maximum document length	356 mm	
Resolution	Color	200 x 200 dpi
	Black	<ul style="list-style-type: none">• Standard: Up to 203 x 98 dpi• Fine: Up to 203 x 196 dpi• Super Fine: Up to 300 x 300 dpi (Receiving only)
Memory	<ul style="list-style-type: none">• 500 Jobs (Tx: 100, Rx: 400)	
Halftone	256 levels	

a. Standard resolution, MMR(JBIG), Maximum modem speed, Phase "C" by ITU-T No. 1 chart, Memory Tx, ECM.

glossary

 The following glossary helps you get familiar with the product by understanding the terminologies commonly used with printing as well as mentioned in this user's guide.

ADF

An Automatic Document Feeder (ADF) is a mechanism that will automatically feed an original sheet of paper so that the machine can scan some amount of the paper at once.

AppleTalk

AppleTalk is a proprietary suite of protocols developed by Apple, Inc for computer networking. It was included in the original Macintosh (1984) and is now deprecated by Apple in favor of TCP/IP networking.

BIT Depth

A computer graphics term describing the number of bits used to represent the color of a single pixel in a bitmapped image. Higher color depth gives a broader range of distinct colors. As the number of bits increases, the number of possible colors becomes impractically large for a color map. 1-bit color is commonly called as monochrome or black and white.

BMP

A bitmapped graphics format used internally by the Microsoft Windows graphics subsystem (GDI), and used commonly as a simple graphics file format on that platform.

BOOTP

Bootstrap Protocol. A network protocol used by a network client to obtain its IP address automatically. This is usually done in the bootstrap process of computers or operating systems running on them. The BOOTP servers assign the IP address from a pool of addresses to each client. BOOTP enables 'diskless workstation' computers to obtain an IP address prior to loading any advanced operating system.

CCD

Charge Coupled Device (CCD) is a hardware which enables the scan job. CCD Locking mechanism is also used to hold the CCD module to prevent any damage when you move the machine.

Collation

Collation is a process of printing a multiple-copy job in sets. When collation is selected, the device prints an entire set before printing additional copies.

Control Panel

A control panel is a flat, typically vertical, area where control or monitoring instruments are displayed. They are typically found in front of the machine.

Coverage

It is the printing term used for a toner usage measurement on printing. For example, 5% coverage means that an A4 sided paper has about 5% image or text on it. So, if the paper or original has complicated images or lots of text on it, the coverage will be higher and at the same time, a toner usage will be as much as the coverage.

CSV

Comma Separated Values (CSV). A type of file format, CSV is used to exchange data between disparate applications. The file format, as it is used in Microsoft Excel, has become a pseudo standard throughout the industry, even among non-Microsoft platforms.

DADF

A Duplex Automatic Document Feeder (DADF) is a mechanism that will automatically feed and flip over an original sheet of paper so that the machine can scan on both sides of the paper.

Default

The value or setting that is in effect when taking a printer out of its box state, reset, or initialized.

DHCP

A Dynamic Host Configuration Protocol (DHCP) is a client-server networking protocol. A DHCP server provides configuration parameters specific to the DHCP client host requesting, generally, information required by the client host to participate on an IP network. DHCP also provides a mechanism for allocation of IP addresses to client hosts.

DIMM

Dual Inline Memory Module (DIMM), a small circuit board that holds memory. DIMM stores all the data within the machine like printing data, received fax data.

DNS

The Domain Name Server (DNS) is a system that stores information associated with domain names in a distributed database on networks, such as the Internet.

Dot Matrix Printer

A dot matrix printer refers to a type of computer printer with a print head that runs back and forth on the page and prints by impact, striking an ink-soaked cloth ribbon against the paper, much like a typewriter.

DPI

Dots Per Inch (DPI) is a measurement of resolution that is used for scanning and printing. Generally, higher DPI results in a higher resolution, more visible detail in the image, and a larger file size.

DRPD

Distinctive Ring Pattern Detection. Distinctive Ring is a telephone company service which enables a user to use a single telephone line to answer several different telephone numbers.

Duplex

A mechanism that will automatically flip over a sheet of paper so that the machine can print (or scan) on both sides of the paper. A printer equipped with a Duplex can print double-sided of paper.

Duty Cycle

Duty cycle is the page quantity which does not affect printer performance for a month. Generally the printer has the lifespan limitation such as pages per year. The lifespan means the average capacity of print-outs, usually within the warranty period. For example, if the duty cycle is 48,000 pages per month assuming 20 working days, a printer limits 2,400 pages a day.

ECM

Error Correction Mode (ECM) is an optional transmission mode built into Class 1 fax machines or fax modems. It automatically detects and corrects errors in the fax transmission process that are sometimes caused by telephone line noise.

Emulation

Emulation is a technique of one machine obtaining the same results as another.

An emulator duplicates the functions of one system with a different system, so that the second system behaves like the first system. Emulation focuses on exact reproduction of external behavior, which is in contrast to simulation, which concerns an abstract model of the system being simulated, often considering its internal state.

Ethernet

Ethernet is a frame-based computer networking technology for local area networks (LANs). It defines wiring and signaling for the physical layer, and frame formats and protocols for the media access control (MAC)/data link layer of the OSI model. Ethernet is mostly standardized as IEEE 802.3. It has become the most widespread LAN technology in use during the 1990s to the present.

EtherTalk

A suite of protocols developed by Apple Computer for computer networking. It was included in the original Macintosh (1984) and is now deprecated by Apple in favor of TCP/IP networking.

FDI

Foreign Device Interface (FDI) is a card installed inside the machine to allow a third party device such as a coin operated device or a card reader. Those devices allow the pay-for-print service on your machine.

FTP

A File Transfer Protocol (FTP) is a commonly used protocol for exchanging files over any network that supports the TCP/IP protocol (such as the Internet or an intranet).

Fuser Unit

The part of a laser printer that melts the toner onto the print media. It consists of a hot roller and a back-up roller. After toner is transferred onto the paper, the fuser unit applies heat and pressure to ensure that the toner stays on the paper permanently, which is why paper is warm when it comes out of a laser printer.

Gateway

A connection between computer networks, or between a computer network and a telephone line. It is very popular, as it is a computer or a network that allows access to another computer or network.

Grayscale

A shades of gray that represent light and dark portions of an image when color images are converted to grayscale; colors are represented by various shades of gray.

Halftone

An image type that simulates grayscale by varying the number of dots. Highly colored areas consist of a large number of dots, while lighter areas consist of a smaller number of dots.

HDD

Hard Disk Drive (HDD), commonly referred to as a hard drive or hard disk, is a non-volatile storage device which stores digitally-encoded data on rapidly rotating platters with magnetic surfaces.

IEEE

The Institute of Electrical and Electronics Engineers (IEEE) is an international non-profit, professional organization for the advancement of technology related to electricity.

IEEE 1284

The 1284 parallel port standard was developed by the Institute of Electrical and Electronics Engineers (IEEE). The term "1284-B" refers to a specific connector type on the end of the parallel cable that attaches to the peripheral (for example, a printer).

Intranet

A private network that uses Internet Protocols, network connectivity, and possibly the public telecommunication system to securely share part of an organization's information or operations with its employees. Sometimes the term refers only to the most visible service, the internal website.

IP address

An Internet Protocol (IP) address is a unique number that devices use in order to identify and communicate with each other on a network utilizing the Internet Protocol standard.

IPM

The Images Per Minute (IPM) is a way of measuring the speed of a printer. An IPM rate indicates the number of single-sided sheets a printer can complete within one minute.

IPP

The Internet Printing Protocol (IPP) defines a standard protocol for printing as well as managing print jobs, media size, resolution, and so forth. IPP can be used locally or over the Internet to hundreds of printers, and also supports access control, authentication, and encryption, making it a much more capable and secure printing solution than older ones.

IPX/SPX

IPX/SPX stands for Internet Packet Exchange/Sequenced Packet Exchange. It is a networking protocol used by the Novell NetWare operating systems. IPX and SPX both provide connection services similar to TCP/IP, with the IPX protocol having similarities to IP, and SPX having similarities to TCP. IPX/SPX was primarily designed for local area networks (LANs), and is a very efficient protocol for this purpose (typically its performance exceeds that of TCP/IP on a LAN).

ISO

The International Organization for Standardization (ISO) is an international standard-setting body composed of representatives from national standards bodies. It produces world-wide industrial and commercial standards.

ITU-T

The International Telecommunication Union is an international organization established to standardize and regulate international radio and telecommunications. Its main tasks include standardization, allocation of the radio spectrum, and organizing interconnection arrangements between different countries to allow international phone calls. A -T out of ITU-T indicates telecommunication.

ITU-T No. 1 chart

Standardized test chart published by ITU-T for document facsimile transmissions.

JBIG

Joint Bi-level Image Experts Group (JBIG) is an image compression standard with no loss of accuracy or quality, which was designed for compression of binary images, particularly for faxes, but can also be used on other images.

JPEG

Joint Photographic Experts Group (JPEG) is a most commonly used standard method of lossy compression for photographic images. It is the format used for storing and transmitting photographs on the World Wide Web.

LDAP

The Lightweight Directory Access Protocol (LDAP) is a networking protocol for querying and modifying directory services running over TCP/IP.

LED

A Light-Emitting Diode (LED) is a semiconductor device that indicates the status of a machine.

MAC address

Media Access Control (MAC) address is a unique identifier associated with a network adapter. MAC address is a unique 48-bit identifier usually written as 12 hexadecimal characters grouped in pairs (e. g., 00-00-0c-34-11-4e). This address is usually hard-coded into a Network Interface Card (NIC) by its manufacturer, and used as an aid for routers trying to locate machines on large networks.

MFP

Multi Function Peripheral (MFP) is an office machine that includes the following functionality in one physical body, so as to have a printer, a copier, a fax, a scanner and etc.

MH

Modified Huffman (MH) is a compression method for decreasing the amount of data that needs to be transmitted between the fax machines to transfer the image recommended by ITU-T T.4. MH is a codebook-based run-length encoding scheme optimized to efficiently compress white space. As most faxes consist mostly of white space, this minimizes the transmission time of most faxes.

MMR

Modified Modified READ (MMR) is a compression method recommended by ITU-T T.6.

Modem

A device that modulates a carrier signal to encode digital information, and also demodulates such a carrier signal to decode transmitted information.

MR

Modified Read (MR) is a compression method recommended by ITU-T T.4. MR encodes the first scanned line using MH. The next line is compared to the first, the differences determined, and then the differences are encoded and transmitted.

NetWare

A network operating system developed by Novell, Inc. It initially used cooperative multitasking to run various services on a PC, and the network protocols were based on the archetypal Xerox XNS stack. Today NetWare supports TCP/IP as well as IPX/SPX.

OPC

Organic Photo Conductor (OPC) is a mechanism that makes a virtual image for print using a laser beam emitted from a laser printer, and it is usually green or gray colored and a cylinder shaped.

An exposing unit of a drum is slowly worn away by its usage of the printer, and it should be replaced appropriately since it gets scratches from grits of a paper.

Originals

The first example of something, such as a document, photograph or text, etc, which is copied, reproduced or translated to produce others, but which is not itself copied or derived from something else.

OSI

Open Systems Interconnection (OSI) is a model developed by the International Organization for Standardization (ISO) for communications. OSI offers a standard, modular approach to network design that divides the required set of complex functions into manageable, self-contained, functional layers. The layers are, from top to bottom, Application, Presentation, Session, Transport, Network, Data Link and Physical.

PABX

A private automatic branch exchange (PABX) is an automatic telephone switching system within a private enterprise.

PCL

Printer Command Language (PCL) is a Page Description Language (PDL) developed by HP as a printer protocol and has become an industry standard. Originally developed for early inkjet printers, PCL has been released in varying levels for thermal, matrix printer, and page printers.

PDF

Portable Document Format (PDF) is a proprietary file format developed by Adobe Systems for representing two dimensional documents in a device independent and resolution independent format.

PostScript

PostScript (PS) is a page description language and programming language used primarily in the electronic and desktop publishing areas. - that is run in an interpreter to generate an image.

Printer Driver

A program used to send commands and transfer data from the computer to the printer.

Print Media

The media like paper, envelopes, labels, and transparencies which can be used on a printer, a scanner, a fax or, a copier.

PPM

Pages Per Minute (PPM) is a method of measurement for determining how fast a printer works, meaning the number of pages a printer can produce in one minute.

PRN file

An interface for a device driver, this allows software to interact with the device driver using standard input/output system calls, which simplifies many tasks.

Protocol

A convention or standard that controls or enables the connection, communication, and data transfer between two computing endpoints.

PS

See PostScript.

PSTN

The Public-Switched Telephone Network (PSTN) is the network of the world's public circuit-switched telephone networks which, on industrial premises, is usually routed through the switchboard.

Resolution

The sharpness of an image, measured in Dots Per Inch (DPI). The higher the dpi, the greater the resolution.

SMB

Server Message Block (SMB) is a network protocol mainly applied to share files, printers, serial ports, and miscellaneous communications between nodes on a network. It also provides an authenticated Inter-process communication mechanism.

SMTP

Simple Mail Transfer Protocol (SMTP) is the standard for e-mail transmissions across the Internet. SMTP is a relatively simple, text-based protocol, where one or more recipients of a message are specified, and then the message text is transferred. It is a client-server protocol, where the client transmits an email message to the server.

Subnet Mask

The subnet mask is used in conjunction with the network address to determine which part of the address is the network address and which part is the host address.

TCP/IP

The Transmission Control Protocol (TCP) and the Internet Protocol (IP); the set of communications protocols that implement the protocol stack on which the Internet and most commercial networks run.

TCR

Transmission Confirmation Report (TCR) provides details of each transmission such as job status, transmission result and number of pages sent. This report can be set to print after each job or only after failed transmissions.

TIFF

Tagged Image File Format (TIFF) is a variable-resolution bitmapped image format. TIFF describes image data that typically come from scanners. TIFF images make use of tags, keywords defining the characteristics of the image that is included in the file. This flexible and platform-independent format can be used for pictures that have been made by various image processing applications.

Toner Cartridge

A kind of bottle within a machine like printer which contains toner. Toner is a powder used in laser printers and photocopiers, which forms the text and images on the printed paper. Toner can be melted by the heat of the fuser, causing it to bind to the fibers in the paper.

TWAIN

An industry standard for scanners and software. By using a TWAIN-compliant scanner with a TWAIN-compliant program, a scan can be initiated from within the program.; an image capture API for Microsoft Windows and Apple Macintosh operating systems.

UNC Path

Uniform Naming Convention (UNC) is a standard way to access network shares in Window NT and other Microsoft products. The format of a UNC path is: \\<servername>\<sharename>\<Additional directory>

URL

Uniform Resource Locator (URL) is the global address of documents and resources on the Internet. The first part of the address indicates what protocol to use, the second part specifies the IP address or the domain name where the resource is located.

USB

Universal Serial Bus (USB) is a standard that was developed by the USB Implementers Forum, Inc., to connect computers and peripherals. Unlike the parallel port, USB is designed to concurrently connect a single computer USB port to multiple peripherals.

Watermark

A watermark is a recognizable image or pattern in paper that appears lighter when viewed by transmitted light. Watermarks were first introduced in Bologna, Italy in 1282; they have been used by papermakers to identify their product, and also on postage stamps, currency, and other government documents to discourage counterfeiting.

WIA

Windows Imaging Architecture (WIA) is an imaging architecture that is originally introduced in Windows Me and Windows XP. A scan can be initiated from within these operating systems by using a WIA-compliant scanner.

index

A

accessories
installing
 hard disk 95
 wireless network interface card 93

Address Book

group dial numbers 57
speed buttons 56
speed dial numbers 56

Address Book, use 47

ADF 19

ADF rubber pad, replace 68

ADF, load 32

adjustment
altitude 28

alarm sound 29

Ans/Fax mode, receiving mode 52

C

characters, enter 29

cleaning
inside 62
outside 62
scan unit 64

clock mode 29

collation, special copy 40

control panel 20

copying

2-up, 4-up 40
book 41
clone 41
collation 40
darkness 39
default setting, change 40
edge erase 42
ID card copy 40
margin shift 41
original type 39
poster 41
time out, set 42

D

date and time, set 29

default mode, change 29

delayed fax 53

demo page, print 25

display language, change 28

driver
installation 27

DRPD (Distinctive Ring Pattern Detection)
52

E

edge erase, special copy 42

F

fax header, set 50

Fax mode, receiving mode 52

fax number, set 50

faxing

default settings, change 56
delayed faxes 53
fax setup 55
forwarding faxes 54
Multiple Send faxes 53
priority faxes 54
receiving faxes 51
sending faxes 51

Forwarding 54

G

Group dial numbers, set 57

H

hard disk
installing 95
use 96

I

ID card, special copy 40

ID copy 20, 21

installing accessories
hard disk 95
network interface card 93

J

jam

clearing paper from the tray 72
tips for avoiding paper jams 70

jam, clear
document 70

job timeout, set 30

K

key sound 29

L

LED
Status 22

Linux problems 87

loading originals
ADF 32
scanner glass 32

M

machine ID, set 50

Maintenance
maintenance parts 68
toner cartridge 64

margin shift, special copy 41

memory module
installing 92
ordering 90

memory, clear 62

Multiple Send faxes 53

N

network
setting up 25

network interface card, install 93

O

optional tray 68, 90

originals
jam, clear 70
loading 32

P

- paper
 - changing the size 36
 - clearing jam 72
 - loading in the multi-purpose tray 37
 - loading in the optional tray 36
 - loading in the tray 1 36
- paper tray, set
 - copy 39
 - fax 51
- paper type
 - setting 38
- PostScript
 - problems 86
- power save mode 30
- print quality problems, solve 82
- printing
 - demo page 25
 - reports 61
 - USB memory 59
- priority fax 54
- problem, solve
 - copying 84
 - faxing 85
 - Linux 87
 - Network Scan 85
 - paper feeding 80
 - printing quality 82
 - scanning 85
 - Windows 86

R

- receiving a fax
 - in Ans/Fax mode 52
 - in DRPD mode 52
 - in Fax mode 52
 - in Secure Receiving mode 52
 - in Tel mode 52
 - in the memory 48
- receiving modes 51
- redialing
 - automatically 51
 - manually 51
- replacing
 - ADF rubber pad 68
- replacing components
 - toner cartridge 65
- replacing, toner cartridge 66
- reports, print 61
- ringer 29

S

- scan power save mode 30
- scanner glass
 - cleaning 64
 - loading documents 32
- scanning
 - default setting, change 46
 - to email 45
 - to FTP server 46
 - to SMB server 46
 - USB flash memory 58
- secure receiving mode 52
- sending a fax
 - automatically 51
- setting
 - font 31
- sounds, set 29
- speaker sound 29
- speaker volume 29
- special copy features 40
- speed buttons, set 56
- speed dial numbers, set 56
- supplies
 - checking life 68
 - expected toner cartridge life 64

T

- Tel mode, receiving mode 52
- toner cartridge
 - replacing 66
- tray
 - adjusting the width and length 36

U

- USB flash memory
 - data backup 59
 - managing 60
 - printing 59
 - scanning 58
- using
 - SetIP 26

V

- volume, adjust
 - ringer 29
 - speaker 29

W

- Windows problems 86
- wireless network interface card, install 93



Software section

SOFTWARE SECTION

CONTENTS

Chapter 1: INSTALLING PRINTER SOFTWARE IN WINDOWS

Installing Printer Software	5
Installing Software for Local Printing	5
Installing Software for Network Printing	8
Reinstalling Printer Software	11
Removing Printer Software	12
Installing mono printer driver	12

Chapter 2: BASIC PRINTING

Printing a Document	14
Printing to a file (PRN)	14
Printer Settings	15
Layout Tab	15
Paper Tab	16
Graphics Tab	17
Extras Tab	17
About Tab	18
Printer Tab	18
Using a Favorite Setting	18
Using Help	18

Chapter 3: ADVANCED PRINTING

Printing Multiple Pages on One Sheet of Paper (N-Up Printing)	19
Printing Posters	20
Printing Booklets	20
Printing on Both Sides of Paper	21
Printing a Reduced or Enlarged Document	21
Fitting Your Document to a Selected Paper Size	21

Using Watermarks	22
Using an Existing Watermark	22
Creating a Watermark	22
Editing a Watermark	22
Deleting a Watermark	22
Using Overlays	23
What is an Overlay?	23
Creating a New Page Overlay	23
Using a Page Overlay	23
Deleting a Page Overlay	23

Chapter 4: USING WINDOWS POSTSCRIPT DRIVER

Printer Settings	24
Advanced	24
Using Help	24

Chapter 5: USING DIRECT PRINTING UTILITY

Overview Direct Printing Utility	25
Printing	25
From the Direct Printing Utility window	25
Using the shortcut icon	25
Using the right-click menu	25

Chapter 6: SHARING THE PRINTER LOCALLY

Setting Up a Host Computer	26
Setting Up a Client Computer	26

Chapter 7: SCANNING

Scanning Using SmarThru Office	27
Using SmarThru Office	27
Uninstalling SmarThru Office	29
Using Onscreen Help File	29
Scanning Process with TWAIN-enabled Software	29
Scanning Using the WIA Driver	29
Windows XP	29
Windows Vista	29

Chapter 8: USING SMART PANEL

Understanding Smart Panel	30
Opening the Troubleshooting Guide	31
Using Printer Settings Utility	31
Using Onscreen Help File	31
Changing the Smart Panel Program Settings	31

Chapter 9: USING YOUR PRINTER IN LINUX

Getting Started	32
Installing the Unified Linux Driver	32
Installing the Unified Linux Driver	32
Uninstalling the Unified Linux Driver	33
Using SetIP program	34
Starting the program	34
Using the Unified Driver Configurator	34
Opening the Unified Driver Configurator	34
Printers Configuration	35
Scanners Configuration	36
Ports Configuration	36
Configuring Printer Properties	37
Printing a Document	37
Printing from Applications	37
Printing Files	38
Scanning a Document	38
Using the Image Manager	39

Chapter 10: USING YOUR PRINTER WITH A MACINTOSH

Installing Software	41
Uninstalling software	41
Using SetIP program	42
Setting Up the Printer	42
For a Network-connected Macintosh	42
For a USB-connected	43
Printing	44
Printing a Document	44
Changing Printer Settings	44
Printing Multiple Pages on One Sheet of Paper	46
Duplex Printing	46
Scanning	47
Scanning with USB	47
Scanning with network	47
Setting scan information in Scan Manager.	47

1 Installing Printer Software in Windows

This chapter includes:

- **Installing Printer Software**
- **Reinstalling Printer Software**
- **Removing Printer Software**
- **Installing mono printer driver**

NOTE: The following procedure is based on Windows XP, for other operating systems, refer to the corresponding Windows user's guide or online help.

Installing Printer Software

You can install the printer software for local printing or network printing. To install the printer software on the computer, perform the appropriate installation procedure depending on the printer in use.

A printer driver is software that lets your computer communicate with your printer. The procedure to install drivers may differ depending on the operating system you are using.

All applications should be closed on your PC before beginning installation.

Installing Software for Local Printing

A local printer is a printer directly attached to your computer using the printer cable supplied with your printer, such as a USB or parallel cable. If your printer is attached to a network, skip this step and go to "Installing Software for Network Printing" on page 8.

You can install the printer software using the typical or custom method.

NOTE: If the "New Hardware Wizard" window appears during the installation procedure, click  in the upper right corner of the box to close the window, or click **Cancel**.

Typical Installation

This is recommended for most users. All components necessary for printer operations will be installed.

- 1 Make sure that the printer is connected to your computer and powered on.
- 2 Insert the supplied CD-ROM into your CD-ROM drive. The CD-ROM should automatically run, and an installation window appears. If the installation window does not appear, click **Start** and then **Run**. Type **X:\Setup.exe**, replacing "X" with the letter which represents your drive and click **OK**. If you use Windows Vista, click **Start** → **All programs** → **Accessories** → **Run**, and type **X:\Setup.exe**. If the **AutoPlay** window appears in Windows Vista, click **Run Setup.exe** in **Install or run program** field, and click **Continue** in the **User Account Control** window.
- 3 Click **Next**.

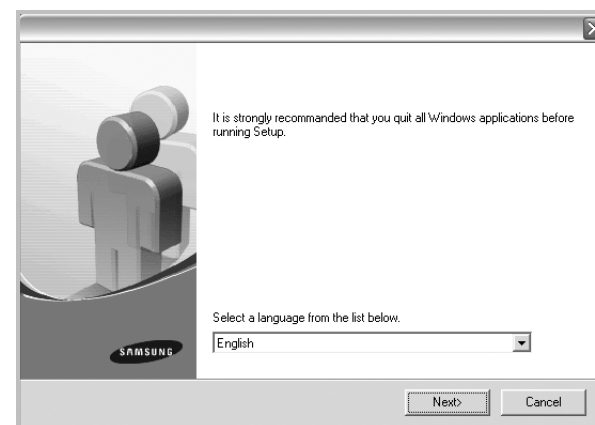

- If necessary, select a language from the drop-down list.

- 4 Select **Typical installation for a local printer**. Click **Next**.

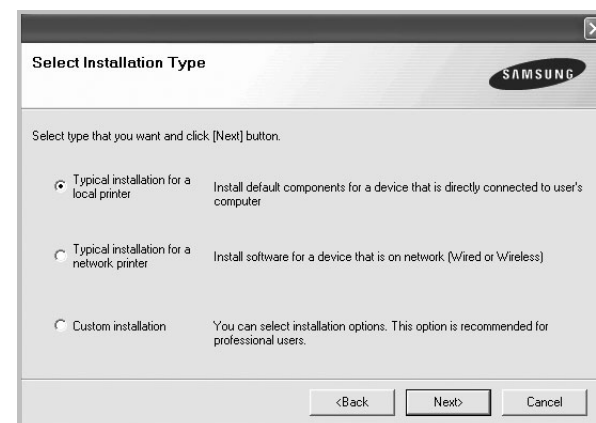

NOTE: If your printer is not already connected to the computer, the following window will appear.

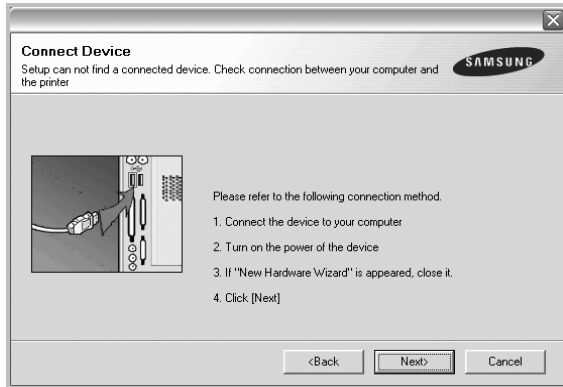

- After connecting the printer, click **Next**.
- If you don't want to connect the printer at this time, click **Next**, and **No** on the following screen. Then the installation will start and a test page will not be printed at the end of the installation.
- *The installation window that appears in this User's Guide may differ depending on the printer and interface in use.*

- 5 After the installation is finished, a window asking you to print a test page appears. If you choose to print a test page, select the checkbox and click **Next**. Otherwise, just click **Next** and skip to step 7.
- 6 If the test page prints out correctly, click **Yes**. If not, click **No** to reprint it.
- 7 To register yourself as a user of Samsung Printers in order to receive information from Samsung, select the checkbox and click **Finish**. You are now sent to the Samsung web site. Otherwise, just click **Finish**.

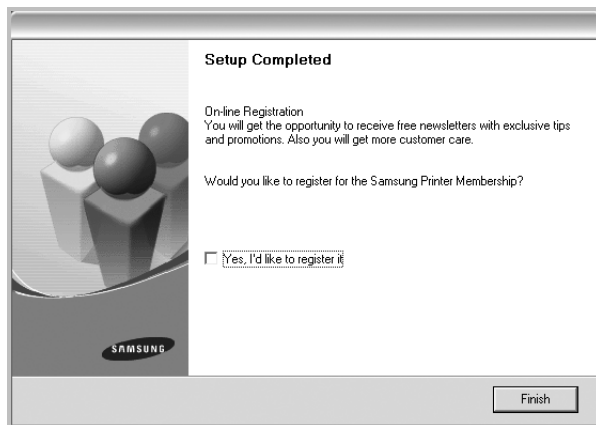

NOTE: After setup is complete, if your printer driver doesn't work properly, reinstall the printer driver. See "Reinstalling Printer Software" on page 11.

Custom Installation

You can choose individual components to install.

- 1 Make sure that the printer is connected to your computer and powered on.
- 2 Insert the supplied CD-ROM into your CD-ROM drive. The CD-ROM should automatically run, and an installation window appears. If the installation window does not appear, click **Start** and then **Run**. Type **X:\Setup.exe**, replacing "X" with the letter which represents your drive and click **OK**. If you use Windows Vista, click **Start** → **All programs** → **Accessories** → **Run**, and type **X:\Setup.exe**. If the **AutoPlay** window appears in Windows Vista, click **Run Setup.exe** in **Install or run program** field, and click **Continue** in the **User Account Control** window.
- 3 Click **Next**.

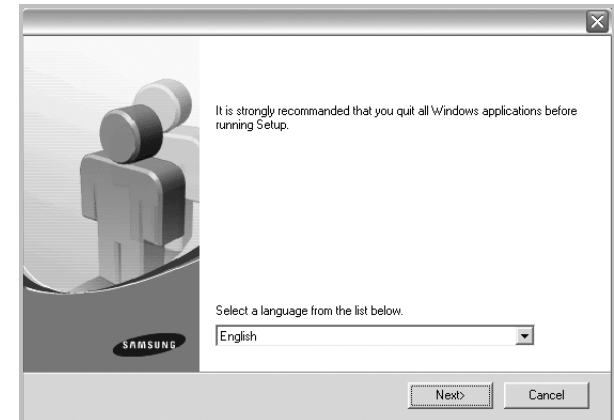

- If necessary, select a language from the drop-down list.
- 4 Select **Custom installation**. Click **Next**.

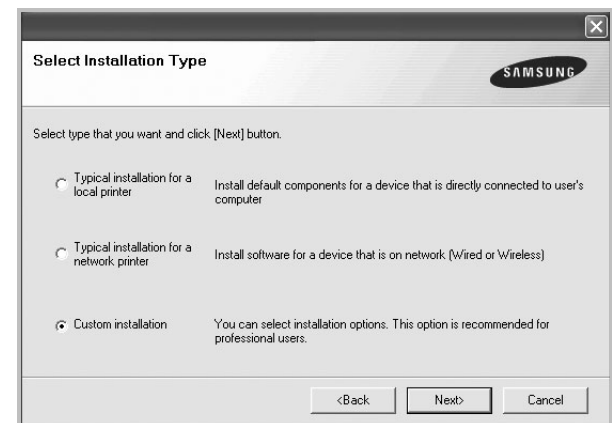

5 Select your printer and click **Next**.

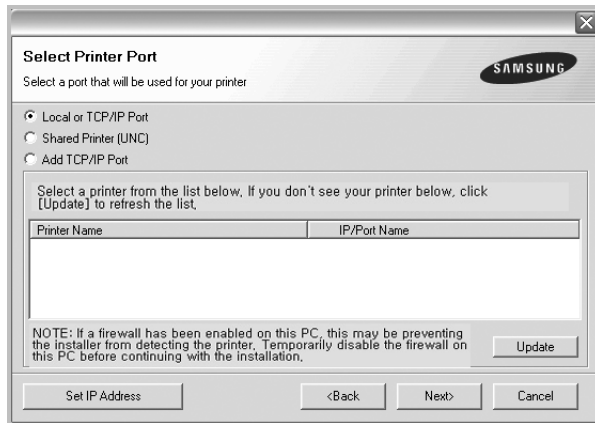

NOTE: If your printer is not already connected to the computer, the following window will appear.

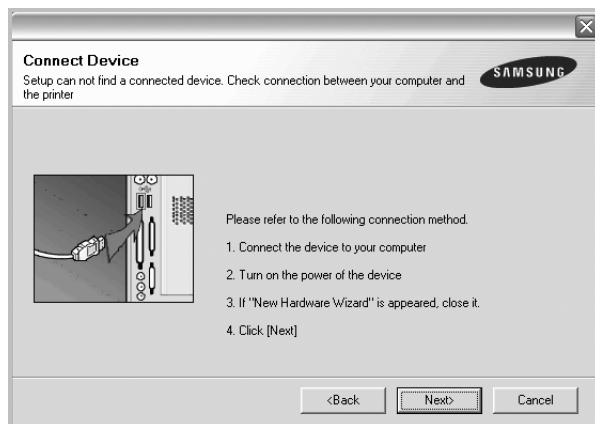

- After connecting the printer, click **Next**.
- If you don't want to connect the printer at this time, click **Next**, and **No** on the following screen. Then the installation will start and a test page will not be printed at the end of the installation.
- *The installation window that appears in this User's Guide may differ depending on the printer and interface in use.*

6 Select the components to be installed and click **Next**.

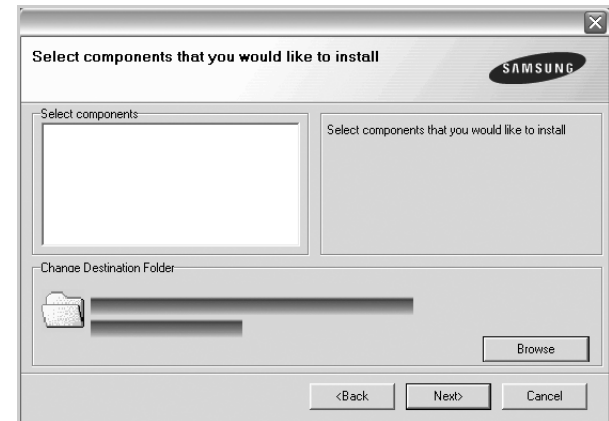

NOTE: You can change the desired installation folder by clicking [**Browse**].

- 7** After the installation is finished, a window asking you to print a test page appears. If you choose to print a test page, select the checkbox and click **Next**. Otherwise, just click **Next** and skip to step 9.
- 8** If the test page prints out correctly, click **Yes**. If not, click **No** to reprint it.
- 9** To register yourself as a user of Samsung Printers in order to receive information from Samsung, select the checkbox and click **Finish**. You are now sent to the Samsung web site. Otherwise, just click **Finish**.

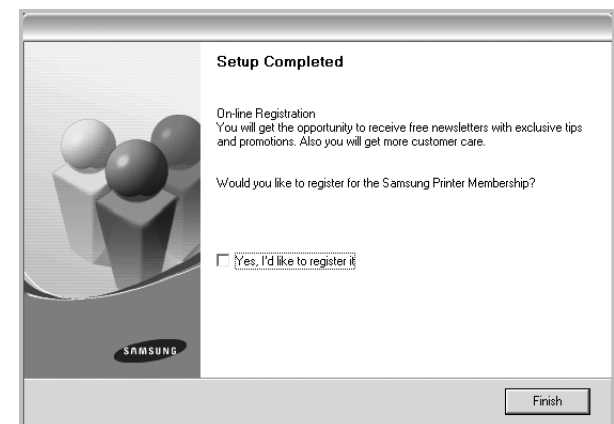

Installing Software for Network Printing

When you connect your printer to a network, you must first configure the TCP/IP settings for the printer. After you have assigned and verified the TCP/IP settings, you are ready to install the software on each computer on the network.

You can install the printer software using the typical or custom method.

Typical Installation

This is recommended for most users. All components necessary for printer operations will be installed.

- 1 Make sure that the printer is connected to your network and powered on. For details about connecting to the network, see the supplied printer's User's Guide.
- 2 Insert the supplied CD-ROM into your CD-ROM drive. The CD-ROM should automatically run, and an installation window appears. If the installation window does not appear, click **Start** and then **Run**. Type **X:\Setup.exe**, replacing "X" with the letter which represents your drive and click **OK**. If you use Windows Vista, click **Start** → **All programs** → **Accessories** → **Run**, and type **X:\Setup.exe**. If the **AutoPlay** window appears in Windows Vista, click **Run Setup.exe** in **Install or run program** field, and click **Continue** in the **User Account Control** window.
- 3 Click **Next**.

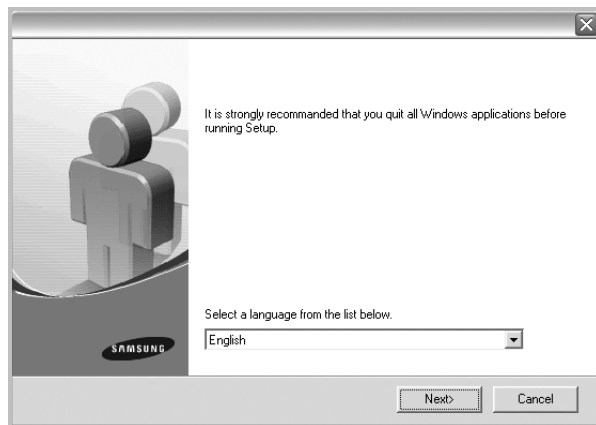

- If necessary, select a language from the drop-down list.

- 4 Select **Typical installation for a network printer**. Click **Next**.

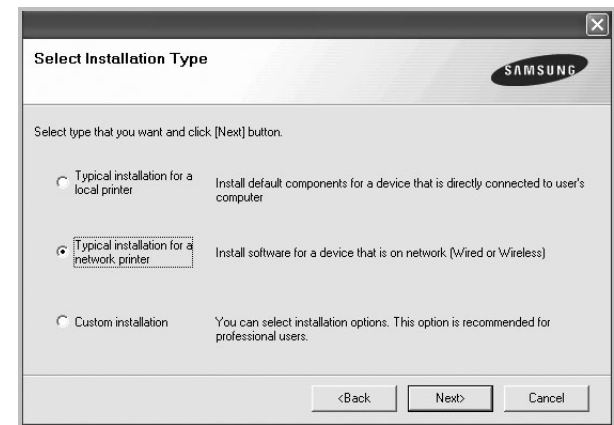

NOTE: If your printer is not connected to the network, the following window will appear. Select a setup option you want, click **Next**.

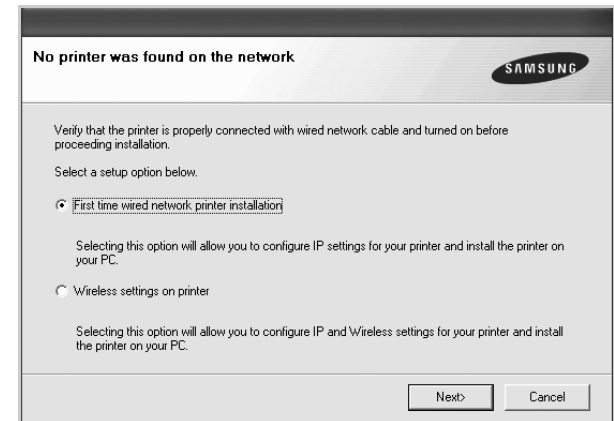

Then the **Set IP Address** window appears. Do as follows:

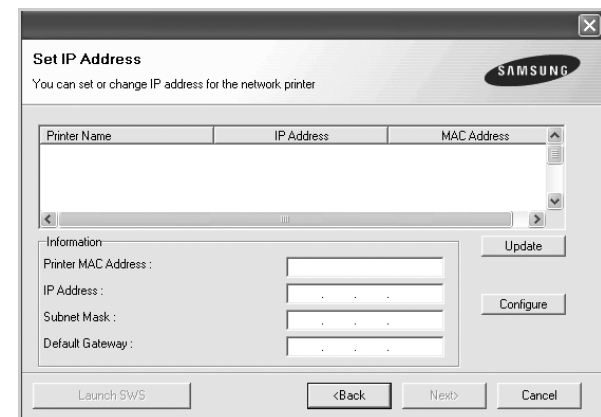

1. Select a printer to be set with a specific IP address from the list.

2. Configure an IP address, subnet mask, and gateway for the printer manually and click **Configure** to set the specific IP address for the network printer.
3. Click **Next**, and go to step 6.

You can also set the network printer via **SyncThru™ Web Service**, an embedded web server. Click **Launch SWS** on **Set IP Address** window. Your machine's embedded website opens.

- 5 The list of printers available on the network appears. Select the printer you want to install from the list and then click **Next**.

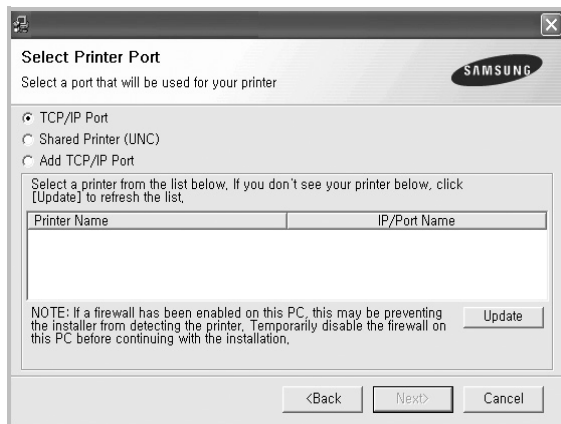

- If you do not see your printer on the list, click **Update** to refresh the list, or select **Add TCP/IP Port** to add your printer to the network. To add the printer to the network, enter the port name and the IP address for the printer.

To verify your printer's IP address or the MAC address, print a Network Configuration page in machine.

- To find a shared network printer (UNC Path), select **Shared Printer [UNC]** and enter the shared name manually or find a shared printer by clicking the **Browse** button.

NOTE: If you cannot find your machine in network, please turn off the firewall and click **Update**.

For Windows operating system, click **Start** → **Control Panel** and start windows firewall, and set this option unactivated. For other operating system, refer to its on-line guide.

- 6 After the installation is finished, a window appears asking you to print a test page and to register yourself as a user of Samsung Printers in order to receive information from Samsung. If you so desire, select the corresponding checkbox(es) and click **Finish**.

Otherwise, just click **Finish**.

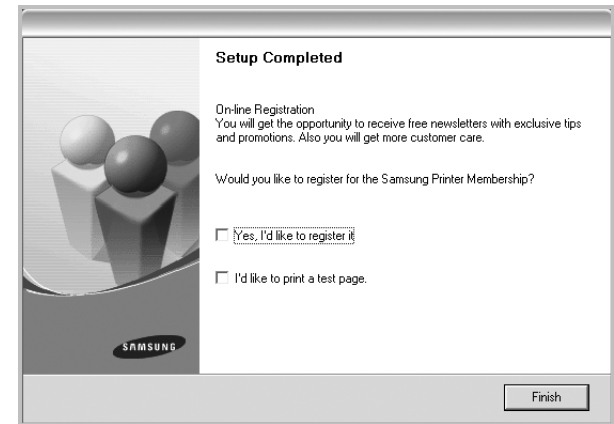

NOTE: After setup is complete, if your printer driver doesn't work properly, reinstall the printer driver. See "Reinstalling Printer Software" on page 11.

Custom Installation

You can choose individual components to install and set a specific IP address.

- 1 Make sure that the printer is connected to your network and powered on. For details about connecting to the network, see the supplied printer's User's Guide.
- 2 Insert the supplied CD-ROM into your CD-ROM drive. The CD-ROM should automatically run, and an installation window appears. If the installation window does not appear, click **Start** and then **Run**. Type **X:\Setup.exe**, replacing "X" with the letter which represents your drive and click **OK**. If you use Windows Vista, click **Start** → **All programs** → **Accessories** → **Run**, and type **X:\Setup.exe**. If the **AutoPlay** window appears in Windows Vista, click **Run Setup.exe** in **Install or run program** field, and click **Continue** in the **User Account Control** window.

3 Click **Next**.

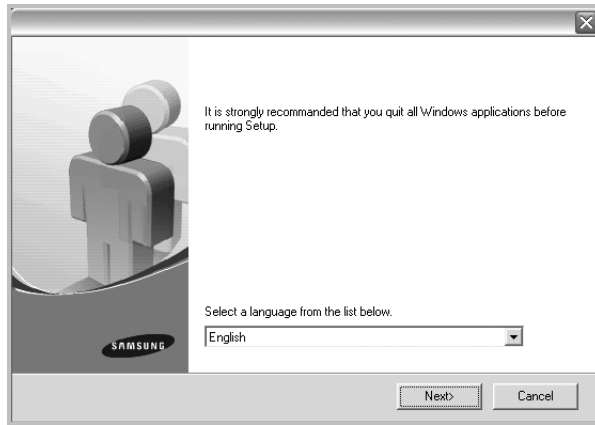

- If necessary, select a language from the drop-down list.

4 Select **Custom installation**. Click **Next**.

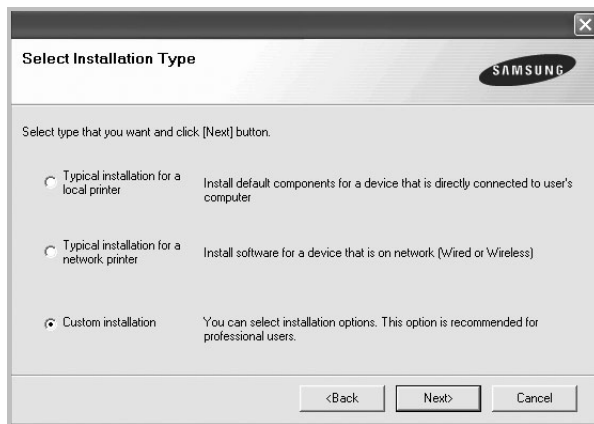

5 The list of printers available on the network appears. Select the printer you want to install from the list and then click **Next**.

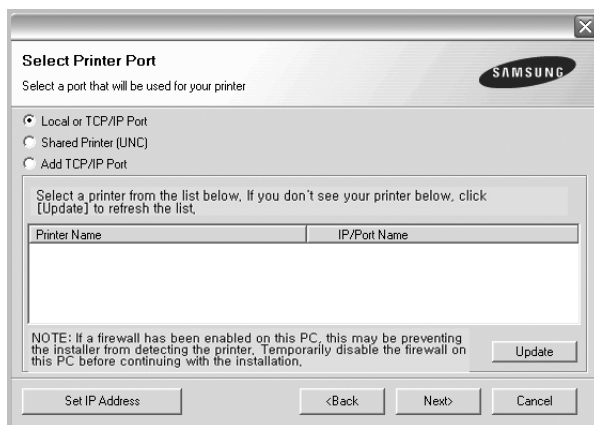

- If you do not see your printer on the list, click **Update** to refresh the list, or select **Add TCP/IP Port** to add your printer to the network. To add the printer to the network, enter the port name and the IP address for the

printer.

To verify your printer's IP address or the MAC address, print a Network Configuration page in machine.

- To find a shared network printer (UNC Path), select **Shared Printer [UNC]** and enter the shared name manually or find a shared printer by clicking the **Browse** button.

NOTE: If you cannot find your machine in network, please turn off the firewall and click **Update**.

For Windows operating system, click **Start** → **Control Panel** and start windows firewall, and set this option unactivated. For other operating system, refer to its on-line guide.

TIP: If you want to set a specific IP address on a specific network printer, click the **Set IP Address** button. The Set IP Address window appears. Do as follows:

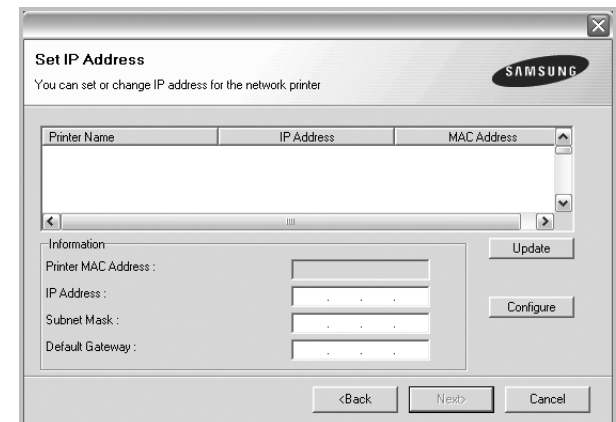

- Select a printer to be set with a specific IP address from the list.
- Configure an IP address, subnet mask, and gateway for the printer manually and click **Configure** to set the specific IP address for the network printer.
- Click **Next**.

You can also set the network printer via **SyncThru™ Web Service**, an embedded web server. Click **Launch SWS** on **Set IP Address** window. Your machine's embedded website opens.

- 6** Select the components to be installed. After selecting the components, the following window appears. You can also change the printer name, set the printer to be shared on

the network, set the printer as the default printer, and change the port name of each printer. Click **Next**.

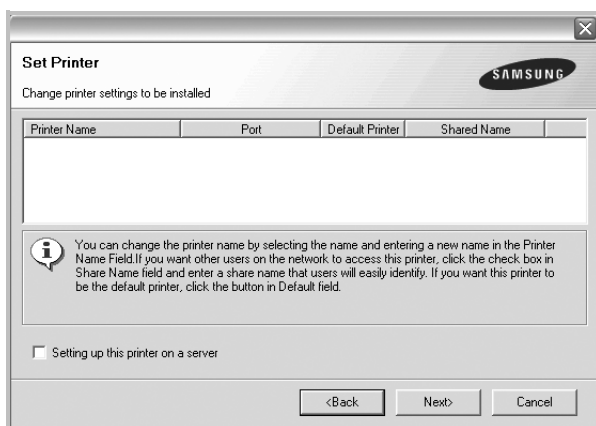

To install this software on a server, select the **Setting up this printer on a server** checkbox.

- 7 After the installation is finished, a window appears asking you to print a test page and to register yourself as a user of Samsung Printers in order to receive information from Samsung. If you so desire, select the corresponding checkbox(es) and click **Finish**.

Otherwise, just click **Finish**.

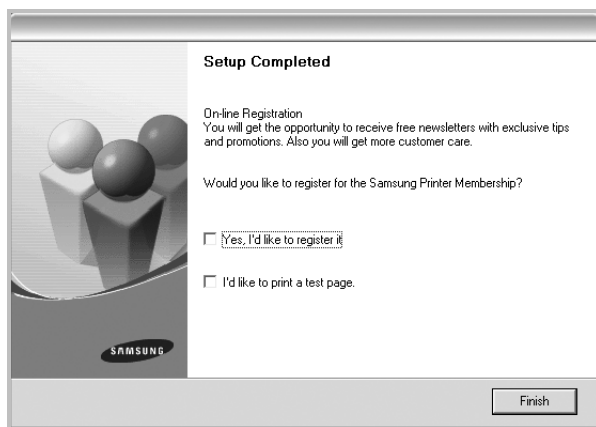

NOTE: After setup is complete, if your printer driver doesn't work properly, reinstall the printer driver. See "Reinstalling Printer Software" on page 11.

Reinstalling Printer Software

You can reinstall the software if installation fails.

- 1 Start Windows.
- 2 From the **Start** menu select **Programs** or **All Programs** → **your printer driver name** → **Maintenance**.
- 3 Select **Repair** and click **Next**.
- 4 The list of printers available on the network appears. Select the printer you want to install from the list and then click **Next**.

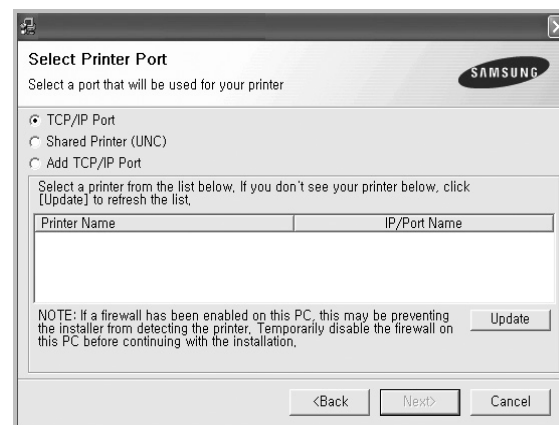

- If you do not see your printer on the list, click **Update** to refresh the list, or select **Add TCP/IP Port** to add your printer to the network. To add the printer to the network, enter the port name and the IP address for the printer.
- To find a shared network printer (UNC Path), select **Shared Printer [UNC]** and enter the shared name manually or find a shared printer by clicking the **Browse** button.

You will see a component list so that you can reinstall any item individually.

NOTE: If your printer is not already connected to the computer, the following window will appear.

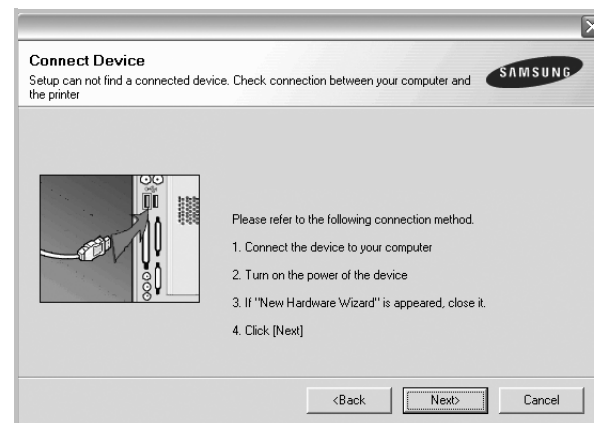

- After connecting the printer, click **Next**.
- If you don't want to connect the printer at this time, click **Next**, and **No** on the following screen. Then the installation will start and a test page will not be printed at the end of the installation.
- *The reinstallation window that appears in this User's Guide may differ depending on the printer and interface in use.*

- 5 Select the components you want to reinstall and click **Next**.
If you installed the printer software for local printing and you select **your printer driver name**, the window asking you to print a test page appears. Do as follows:
 - a. To print a test page, select the check box and click **Next**.
 - b. If the test page prints out correctly, click **Yes**.
If it doesn't, click **No** to reprint it.
- 6 When the reinstallation is done, click **Finish**.

Removing Printer Software

- 1 Start Windows.
- 2 From the **Start** menu select **Programs** or **All Programs** → **your printer driver name** → **Maintenance**.
- 3 Select **Remove** and click **Next**.
You will see a component list so that you can remove any item individually.
- 4 Select the components you want to remove and then click **Next**.
- 5 When your computer asks you to confirm your selection, click **Yes**.
The selected driver and all of its components are removed from your computer.
After the software is removed, click **Finish**.

Installing mono printer driver

This printer features a monochrome only printer. This mono driver limits output to th black toner. You must install the mono driver on your computer. Following steps guide you through the step by step installation process.

- 1 Make sure that the printer is connected to your computer and powered on. Or your computer and printer are connected to the network.
- 2 Insert the supplied CD-ROM into your CD-ROM drive. The CD-ROM should automatically run, and an installation window appears.
- 3 Click **Cancel**.

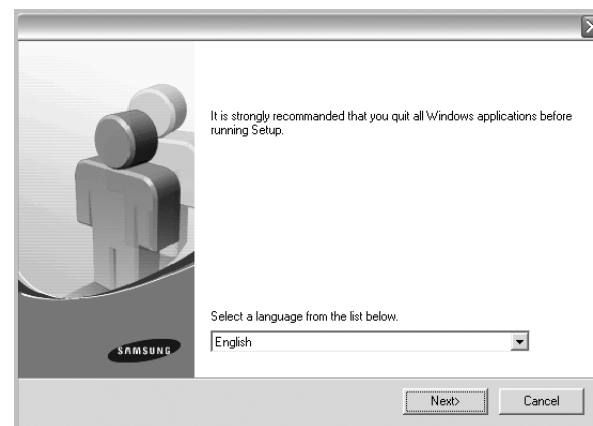

- 4 If the confirmation window appears, click **Finish**.
- 4 Click **Start** → **Printers and Faxes**.
- 5 Select **Add Printer**.
- 6 When **Add Printer Wizard** appears, click **Next**.
- 7 Select **Local printer attached to this computer**, and **Automatically detect and install my Plug and Play printer**, then click **Next**. Go to step 13.
If your computer does not find the printer, then follow the next step.
- 8 Select **Next** in the **Select a Printer Port** window.
- 9 In the **Select a Printer Port** window, select **Have Disk...**
- 10 Click **Browse** to find a mono driver for your printer.
ex) Windows XP 32 bit
Select CD-ROM drive → **Printer** → **PC_MONO** → **WINXP_2000_VISTA-32**
- 11 Select *****.inf** file and click **Open**.
- 12 Click **OK** in the **Install From Disk** window.

13 Select a mono driver in the **Printers** field, and click **Next**.

NOTE: If you have installed a mono driver before, then the **Use Existing Driver** window. Select as the window explains, and click **Next**. Also, depending on your computer configuration, the printer sharing window or the print the test page window may appear; make the appropriate selection.

14 Enter your printer name, and click **Next**.

15 Click **Finish** to start installing a mono printer driver.

16 NOTE: If your printer is connected to a network, go to printer's **Properties** and select the **Ports** tab, then click **Add Port** and **Standard TCP/IP Port**, and create a new port to connect to the printer. To create a new port, follow the procedure laid out in the wizard window.

2 Basic Printing



This chapter explains the printing options and common printing tasks in Windows.

This chapter includes:

- **Printing a Document**
- **Printing to a file (PRN)**
- **Printer Settings**
 - **Layout Tab**
 - **Paper Tab**
 - **Graphics Tab**
 - **Extras Tab**
 - **About Tab**
 - **Printer Tab**
 - **Using a Favorite Setting**
 - **Using Help**

Printing a Document

NOTES:

- Your printer driver **Properties** window that appears in this User's Guide may differ depending on the printer in use. However the composition of the printer properties window is similar.
- **Check the Operating System(s) that are compatible with your printer. Please refer to the OS Compatibility section of Printer Specifications in your Printer User's Guide.**
- If you need to know the exact name of your printer, you can check the supplied CD-ROM.
- When you select an option in printer properties, you may see an exclamation mark  mark or  mark. An exclamation mark means you can select that certain option but it is not recommended, and  mark means you cannot select that option due to the machine's setting or environment.

The following procedure describes the general steps required for printing from various Windows applications. The exact steps for printing a document may vary depending on the application program you are using. Refer to the User's Guide of your software application for the exact printing procedure.

- 1 Open the document you want to print.
- 2 Select **Print** from the **File** menu. The Print window is displayed. It may look slightly different depending on your application.

The basic print settings are selected within the Print window. These settings include the number of copies and print range.

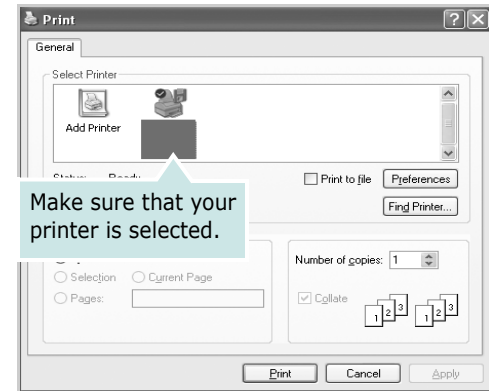

- 3 Select **your printer driver** from the **Name** drop-down list.

To take advantage of the printer features provided by your printer driver, click **Properties** or **Preferences** in the application's Print window. For details, see "Printer Settings" on page 15.

If you see **Setup, Printer, or Options** in your Print window, click it instead. Then click **Properties** on the next screen.

Click **OK** to close the printer properties window.

- 4 To start the print job, click **OK** or **Print** in the Print window.

Printing to a file (PRN)

You will sometimes need to save the print data as a file for your purpose.

To create a file:

- 1 Check the **Print to file** box at the **Print** window.

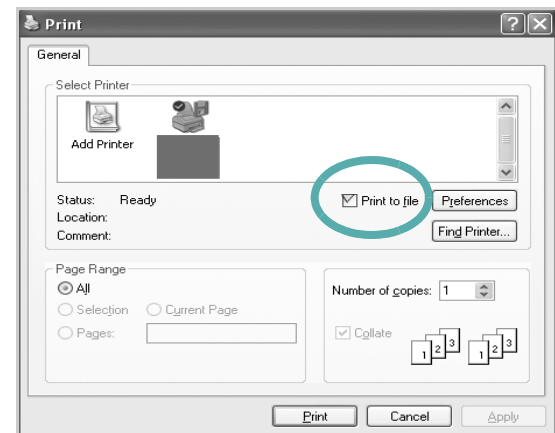

- 2 Select the folder and assign a name of the file and then click **OK**.

Printer Settings

You can use the printer properties window, which allows you to access all of the printer options you need when using your printer. When the printer properties are displayed, you can review and change the settings needed for your print job.

Your printer properties window may differ, depending on your operating system. This Software User's Guide shows the Properties window for Windows XP.

Your printer driver **Properties** window that appears in this User's Guide may differ depending on the printer in use.

If you access printer properties through the Printers folder, you can view additional Windows-based tabs (refer to your Windows User's Guide) and the Printer tab (see "Printer Tab" on page 18).

NOTES:

- Most Windows applications will override settings you specify in the printer driver. Change all print settings available in the software application first, and change any remaining settings using the printer driver.
- The settings you change remain in effect only while you are using the current program. **To make your changes permanent**, make them in the Printers folder.
- The following procedure is for Windows XP. For other Windows OS, refer to the corresponding Windows User's Guide or online help.
 1. Click the Windows **Start** button.
 2. Select **Printers and Faxes**.
 3. Select **your printer driver icon**.
 4. Right-click on the printer driver icon and select **Printing Preferences**.
 5. Change the settings on each tab, click OK.

Layout Tab

The **Layout** tab provides options to adjust how the document appears on the printed page. The **Layout Options** includes **Multiple Pages per Side**, **Poster Printing** and **Booklet Printing**. See "Printing a Document" on page 14 for more information on accessing printer properties.

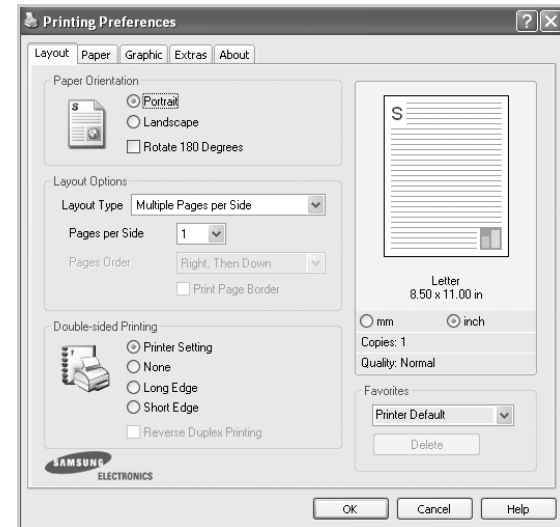

Paper Orientation

Paper Orientation allows you to select the direction in which information is printed on a page.

- **Portrait** prints across the width of the page, letter style.
- **Landscape** prints across the length of the page, spreadsheet style.
- **Rotate** allows you to rotate the page the selected degrees.

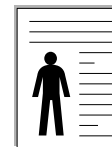

▲ Portrait



▲ Landscape

Layout Options

Layout Options allows you to select advanced printing options. You can choose **Multiple Pages per Side** and **Poster Printing**.

- For details, see "Printing Multiple Pages on One Sheet of Paper (N-Up Printing)" on page 19.
- For details, see "Printing Posters" on page 20
- For details, see "Printing Booklets" on page 20

Double-sided Printing

Double-sided Printing allows you to print on both sides of paper. **If this option does not appear, your printer does not have this feature.**

- For details, see "Printing on Both Sides of Paper" on page 21.

Paper Tab

Use the following options to set the basic paper handling specifications when you access the printer properties. See "Printing a Document" on page 14 for more information on accessing printer properties.

Click the **Paper** tab to access various paper properties.

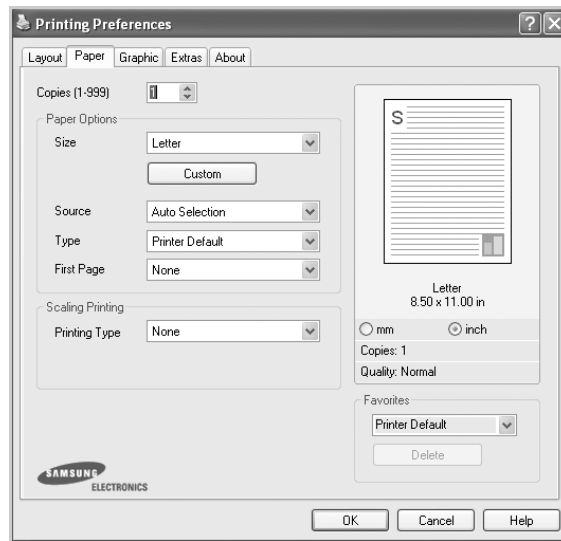

Copies

Copies allows you to choose the number of copies to be printed. You can select 1 to 999 copies.

Paper Options

Size

Size allows you to set the size of paper you loaded in the tray. If the required size is not listed in the **Size** box, click **Custom**. When the **Custom Paper Setting** window appears, set the paper size and click **OK**. The setting appears in the list so that you can select it.

Source

Make sure that **Source** is set to the corresponding paper tray. Use **Multi-Purpose Tray** when printing on special materials like envelopes and transparencies. You have to load one sheet at a time into the Manual Tray or Multi-Purpose Tray. If the paper source is set to **Auto Selection**, the printer automatically picks up print material in the following tray order: Manual Tray or Multi-Purpose Tray, Tray n.

Type

Set **Type** to correspond to the paper loaded in the tray from which you want to print. This will let you get the best quality printout. If not, print quality may not be achieved as you want.

- **Thin Paper:** Less than 19 lb (70 g/m²) thin paper.
- **Thick Paper:** 24 lb to 32 lb (90~120 g/m²) thick paper.
- **Bond Paper:** When you use the bond paper, select this option.

- **Cotton Paper:** 20 lb to 24 lb (75~90 g/m²) cotton paper such as Gilbert 25 % and Gilbert 100 %.
- **Archive Paper:** When you need to keep print-out for a long period time such as archives, select this option.
- **Plain Paper:** Normal plain paper. Select this type if your printer is monochrome and printing on the 16 lb (60 g/m²) cotton paper.
- **Recycled Paper:** 20 lb to 24 lb (75~90 g/m²) recycled paper.
- **Color Paper:** 20 lb to 24 lb (75~90 g/m²) color-backgrounded paper.

First Page

This property allows you to print the first page using a different paper type from the rest of the document. You can select the paper source for the first page. For example, load thick stock for the first page into the Multi-purpose Tray, and plain paper into Tray n. Then, select **Tray n** in the **Source** option and **Multi-Purpose Tray** in the **First Page** option. **If this option does not appear, your printer does not have this feature.**

Scaling Printing

Scaling Printing allows you to automatically or manually scale your print job on a page. You can choose from **None**, **Reduce/Enlarge**, and **Fit to Page**.

- For details, see "Printing a Reduced or Enlarged Document" on page 21.
- For details, see "Fitting Your Document to a Selected Paper Size" on page 21.

Graphics Tab

Use the following Graphic options to adjust the print quality for your specific printing needs. See “Printing a Document” on page 14 for more information on accessing printer properties.

Click the **Graphic** tab to display the properties shown below.

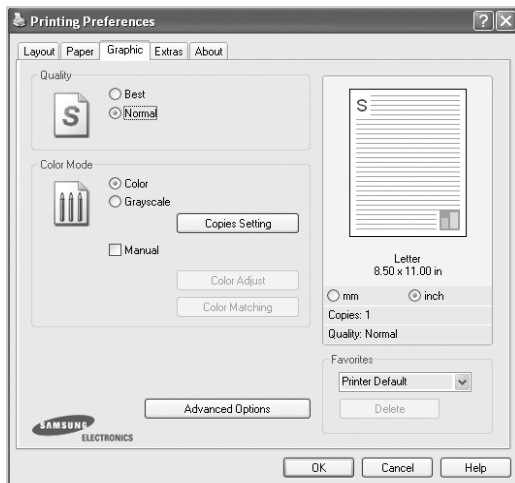

Quality

The Quality options you can select may vary depending on your printer model. The higher the setting, the sharper the clarity of printed characters and graphics. The higher setting also may increase the time it takes to print a document.

Color Mode

You can choose color options. Setting to **Color** typically produces the best possible print quality for color documents. If you want to print a color document in grayscale, select **Grayscale**. If you want to adjust the color options manually, select **Manual** and click the **Color Adjust** or **Color Matching** button.

- **Copies Setting** : In order to use this option, first you need to set total number of copies from **Paper** tab. When you make several copies, and if you want to print some copies in color and some in grayscale, use this option and select the number of copies in grayscale.
- **Color Adjust** : You can adjust the appearance of images by changing the settings in the **Levels** option.
- **Color Matching** : You can adjust the appearance of images by changing the settings in the **Settings** option.

Advanced Options

You can set advanced settings by clicking the **Advanced Options** button.

- **Raster Compression**: This option determines the compression level of images for transferring data from a computer to a printer. If you set this option to Maximum, the printing speed will be high, but the printing quality will be low. *This feature is available only when you use the PCL 6 printer driver.*
- **TrueType Options**: This option determines what the driver tells the printer about how to image the text in your document. Select the appropriate setting according to the status of your document. *This feature is available only when you use the PCL 6 printer driver.*

- **Download as Outline**: When this option is selected, the driver will download any TrueType fonts that are used in your document not already stored (resident) on your printer. If,

after printing a document, you find that the fonts did not print correctly, choose Download as bit image and resubmit your print job. The Download as bit image setting is often useful when printing Adobe. *This feature is available only when you use the PCL 6 printer driver.*

- **Download as Bitmap**: When this option is selected, the driver will download the font data as bitmap images. Documents with complicated fonts, such as Korean or Chinese, or various other fonts, will print faster in this setting. *This feature is available only when you use the PCL 6 printer driver.*
- **Print as Graphics**: When this option is selected, the driver will download any fonts as graphics. When printing documents with high graphic content and relatively few TrueType fonts, printing performance (speed) may be enhanced in this setting. *This feature is available only when you use the PCL 6 printer driver.*

- **Print All Text To Black**: When the **Print All Text To Black** option is checked, all text in your document prints solid black, regardless of the color it appears on the screen.
- **Print All Text To Darken**: When the **Print All Text To Darken** option is checked, all text in your document is allowed to print darker than on a normal document. *(CLX-6200ND, CLX-6200FX, CLX-6210FX only.)*
- **Grayscale Enhancement**: Press the **Smart Color** tab. It allows users to preserve the details of nature photos, and improve contrast and readability among gray scaled colors, when printing color documents in grayscale.
- **Fine Edge**: Press the **Smart Color** tab. It allows users to emphasize edges of texts and fine lines for improving readability and align each color channel registration in color printing mode. *(CLX-6200ND, CLX-6200FX, CLX-6210FX only.)*

Extras Tab

You can select output options for your document. See “Printing a Document” on page 14 for more information about accessing the printer properties.

Click the **Extras** tab to access the following feature:

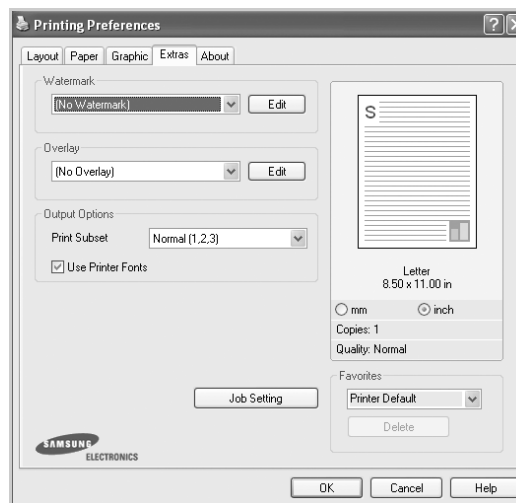

Watermark

You can create a background text image to be printed on each page of your document. For details, see "Using Watermarks" on page 22.

Overlay

Overlays are often used to take the place of preprinted forms and letterhead paper. For details, see "Using Overlays" on page 23.

Output Options

- **Print Subset:** You can set the sequence in which the pages print. Select the print order from the drop-down list.
 - **Normal (1,2,3):** Your printer prints all pages from the first page to the last page.
 - **Reverse All Pages (3,2,1):** Your printer prints all pages from the last page to the first page.
 - **Print Odd Pages:** Your printer prints only the odd numbered pages of the document.
 - **Print Even Pages:** Your printer prints only the even numbered pages of the document.
- **Use Printer Fonts:** When Use Printer Fonts is checked, the printer uses the fonts that are stored in its memory (resident fonts) to print your document, rather than downloading the fonts used in your document. Because downloading fonts takes time, selecting this option can speed up your printing time. When using Printer fonts, the printer will try to match the fonts used in your document to those stored in its memory. If, however, you use fonts in your document that are very different from those resident in the printer, your printed output will appear very different from what it looks like on the screen.
This feature is available only when you use the PCL 6 printer driver.
- **Save as Form for Overlay:** Select Save as Form for Overlay to save the document as a form file (C:\FORMOVER*.FOM). Once this option is selected, the printer driver requires the file name and the destination path each time you print. If you want to preset the file name and specify the path, click on the button in the Output to area, and type the file name and specify the path.
This feature is available only when you use the PCL 6 printer driver.

Job Setting

Job Setting dialog allows you to select how to print or save the printing file by using the optional HDD. *Some printers do not support this feature.*

Using Onscreen Help File

- For more information about **Job Setting**, click  at the top right corner of the window. The **Job Setting** Help window opens and allows you to view onscreen help supplied on the **Job Setting**.

About Tab

Use the **About** tab to display the copyright notice and the version number of the driver. If you have an Internet browser, you can connect to the Internet by clicking on the web site icon. See "Printing a Document" on page 14 for more information about accessing printer properties.

Printer Tab

If you access printer properties through the **Printers** folder, you can view the **Printer** tab. You can set the printer configuration.

The following procedure is for Windows XP. For other Windows OS, refer to the corresponding Windows User's Guide or online help.

- 1 Click the Windows **Start** menu.
- 2 Select **Printers and Faxes**.
- 3 Select **your printer driver** icon.
- 4 Right-click on the printer driver icon and select **Properties**.
- 5 Click the **Printer** tab and set the options.

Using a Favorite Setting

The **Favorites** option, which is visible on each properties tab, allows you to save the current properties settings for future use.

To save a **Favorites** item:

- 1 Change the settings as needed on each tab.
- 2 Enter a name for the item in the **Favorites** input box.

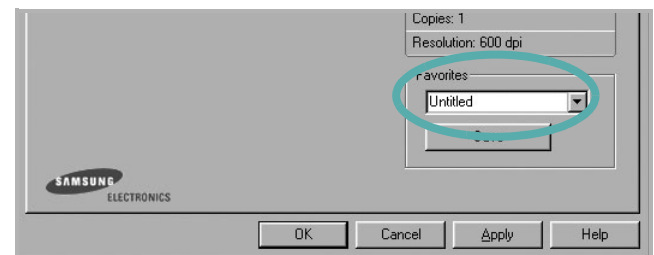

- 3 Click **Save**.

When you save **Favorites**, all current driver settings are saved.

To use a saved setting, select the item from the **Favorites** drop down list. The printer is now set to print according to the Favorites setting you selected.

To delete a Favorites item, select it from the list and click **Delete**.

You can also restore the printer driver's default settings by selecting **Printer Default** from the list.

Using Help

Your printer has a help screen that can be activated by clicking the **Help** button in the printer properties window. These help screens give detailed information about the printer features provided by the printer driver.

You can also click  from the upper right corner of the window, and then click on any setting.

3 Advanced Printing

This chapter explains printing options and advanced printing tasks.

NOTE:

- Your printer driver **Properties** window that appears in this User's Guide may differ depending on the printer in use. However the composition of the printer properties window is similar.
 - If you need to know the exact name of your printer, you can check the supplied CD-ROM.
-

This chapter includes:

- **Printing Multiple Pages on One Sheet of Paper (N-Up Printing)**
- **Printing Posters**
- **Printing Booklets**
- **Printing on Both Sides of Paper**
- **Printing a Reduced or Enlarged Document**
- **Fitting Your Document to a Selected Paper Size**
- **Using Watermarks**
- **Using Overlays**

Printing Multiple Pages on One Sheet of Paper (N-Up Printing)



You can select the number of pages to print on a single sheet of paper. To print more than one page per sheet, the pages will be reduced in size and arranged in the order you specify. You can print up to 16 pages on one sheet.

- 1** To change the print settings from your software application, access printer properties. See "Printing a Document" on page 14.
- 2** From the **Layout** tab, choose **Multiple Pages per Side** in the **Layout Type** drop-down list.
- 3** Select the number of pages you want to print per sheet (1, 2, 4, 6, 9, or 16) in the **Pages per Side** drop-down list.
- 4** Select the page order from the **Page Order** drop-down list, if necessary.
Check **Print Page Border** to print a border around each page on the sheet.
- 5** Click the **Paper** tab, select the paper source, size, and type.
- 6** Click **OK** and print the document.

Printing Posters

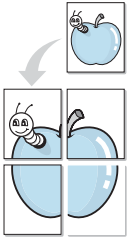

This feature allows you to print a single-page document onto 4, 9, or 16 sheets of paper, for the purpose of pasting the sheets together to form one poster-size document.

- 1 To change the print settings from your software application, access printer properties. See “Printing a Document” on page 14.
- 2 Click the **Layout** tab, select **Poster Printing** in the **Layout Type** drop-down list.
- 3 Configure the poster option:

You can select the page layout from **Poster<2x2>**, **Poster<3x3>**, **Poster<4x4>** or **Custom**. If you select **Poster<2x2>**, the output will be automatically stretched to cover 4 physical pages. If the option is set to Custom, you can enlarge the original from 150% to 400%. Depending on the level of the enlargement, the page layout is automatically adjusted to **Poster<2x2>**, **Poster<3x3>**, **Poster<4x4>**.

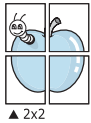

▲ 2x2

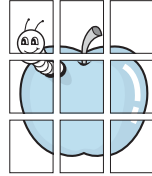

▲ 3x3

Specify an overlap in millimeters or inches to make it easier to pasting the sheets together.

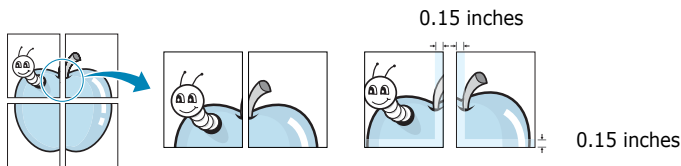

- 4 Click the **Paper** tab, select the paper source, size, and type.
- 5 Click **OK** and print the document. You can complete the poster by pasting the sheets together.

Printing Booklets

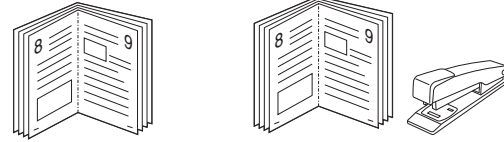

This printer feature allows you to print your document on both sides of the paper and arranges the pages so that the paper can be folded in half after printing to produce a booklet.

- 1 To change the print settings from your software application, access the printer properties. See “Printing a Document” on page 14.
- 2 From the **Layout** tab, choose **Booklet Printing** from the **Layout Type** drop-down list.

NOTE: The **Booklet Printing** option is not available for all paper sizes. In order to find out the available paper size for this feature, select the paper size in the **Size** option on the **Paper** tab, then check if the **Booklet Printing** in a **Layout Type** drop-down list on the **Layout** tab is activated.

- 3 Click the **Paper** tab, and select the paper source, size, and type.
- 4 Click **OK** and print the document.
- 5 After printing, fold and staple the pages.

Printing on Both Sides of Paper

You can print on both sides of a sheet of paper. Before printing, decide how you want your document oriented.

The options are:

- **Printer Setting**, if you select this option, this feature is determined by the setting you've made on the control panel of the printer. *If this option does not appear, your printer does not have this feature.*
- **None**
- **Long Edge**, which is the conventional layout used in book binding.
- **Short Edge**, which is the type often used with calendars.

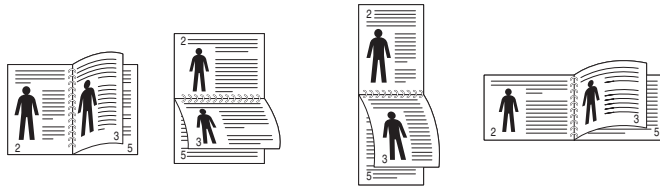

▲ Long Edge

▲ Short Edge

- **Reverse Duplex Printing**, allows you to select general print order compare to duplex print order. *If this option does not appear, your printer does not have this feature.*

NOTE: Do not print on both sides of labels, transparencies, envelopes, or thick paper. Paper jamming and damage to the printer may result.

- 1 To change the print settings from your software application, access printer properties. "Printing a Document" on page 14.
- 2 From the **Layout** tab, select the paper orientation.
- 3 From the **Double-sided Printing** section, select the binding option you want.
- 4 Click the **Paper** tab and select the paper source, size, and type.
- 5 Click **OK** and print the document.

NOTE: If your printer does not have a duplex unit, you should complete the printing job manually. The printer prints every other page of the document first. After printing the first side of your job, the Printing Tip window appears. Follow the on-screen instructions to complete the printing job.

Printing a Reduced or Enlarged Document

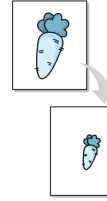

You can change the size of a page's content to appear larger or smaller on the printed page.

- 1 To change the print settings from your software application, access printer properties. See "Printing a Document" on page 14.
- 2 From the **Paper** tab, select **Reduce/Enlarge** in the **Printing Type** drop-down list.
- 3 Enter the scaling rate in the **Percentage** input box. You can also click the ▼ or ▲ button.
- 4 Select the paper source, size, and type in **Paper Options**.
- 5 Click **OK** and print the document.

Fitting Your Document to a Selected Paper Size

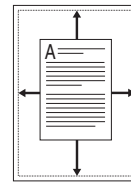

This printer feature allows you to scale your print job to any selected paper size regardless of the digital document size. This can be useful when you want to check fine details on a small document.

- 1 To change the print settings from your software application, access printer properties. See "Printing a Document" on page 14.
- 2 From the **Paper** tab, select **Fit to Page** in the **Printing Type** drop-down list.
- 3 Select the correct size from the **Output size** drop-down list.
- 4 Select the paper source, size, and type in **Paper Options**.
- 5 Click **OK** and print the document.

Using Watermarks

The Watermark option allows you to print text over an existing document. For example, you may want to have large gray letters reading "DRAFT" or "CONFIDENTIAL" printed diagonally across the first page or all pages of a document.

There are several predefined watermarks that come with the printer, and they can be modified, or you can add new ones to the list.

Using an Existing Watermark

- 1 To change the print settings from your software application, access printer properties. See "Printing a Document" on page 14.
- 2 Click the **Extras** tab, and select the desired watermark from the **Watermark** drop-down list. You will see the selected watermark in the preview image.
- 3 Click **OK** and start printing.

NOTE: The preview image shows how the page will look when it is printed.

Creating a Watermark

- 1 To change the print settings from your software application, access printer properties. See "Printing a Document" on page 14.
- 2 Click the **Extras** tab, and click the **Edit** button in the **Watermark** section. The **Edit Watermark** window appears.
- 3 Enter a text message in the **Watermark Message** box. You can enter up to 40 characters. The message displays in the preview window.
When the **First Page Only** box is checked, the watermark prints on the first page only.
- 4 Select watermark options.
You can select the font name, style, size, or grayscale level from the **Font Attributes** section and set the angle of the watermark from the **Message Angle** section.
- 5 Click **Add** to add a new watermark to the list.
- 6 When you have finished editing, click **OK** and start printing.

To stop printing the watermark, select **(No Watermark)** from the **Watermark** drop-down list.

Editing a Watermark

- 1 To change the print settings from your software application, access printer properties. See "Printing a Document" on page 14.
- 2 Click the **Extras** tab and click the **Edit** button in the **Watermark** section. The **Edit Watermark** window appears.
- 3 Select the watermark you want to edit from the **Current Watermarks** list and change the watermark message and options.
- 4 Click **Update** to save the changes.
- 5 Click **OK** until you exit the Print window.

Deleting a Watermark

- 1 To change the print settings from your software application, access printer properties. See "Printing a Document" on page 14.
- 2 From the **Extras** tab, click the **Edit** button in the Watermark section. The **Edit Watermark** window appears.
- 3 Select the watermark you want to delete from the **Current Watermarks** list and click **Delete**.
- 4 Click **OK** until you exit the Print window.

Using Overlays

What is an Overlay?



An overlay is text and/or images stored in the computer hard disk drive (HDD) as a special file format that can be printed on any document. Overlays are often used to take the place of preprinted forms and letterhead paper. Rather than using preprinted letterhead, you can create an overlay containing the exact same information that is currently on your letterhead. To print a letter with your company's letterhead, you do not need to load preprinted letterhead paper in the printer. You need only tell the printer to print the letterhead overlay on your document.

Creating a New Page Overlay



To use a page overlay, you must create a new page overlay containing your logo or image.

- 1 Create or open a document containing text or an image for use in a new page overlay. Position the items exactly as you wish them to appear when printed as an overlay.
- 2 To save the document as an overlay, access printer properties. See "Printing a Document" on page 14.
- 3 Click the **Extras** tab, and click **Edit** button in the **Overlay** section.
- 4 In the Edit Overlay window, click **Create Overlay**.
- 5 In the Create Overlay window, type a name of up to eight characters in the **File name** box. Select the destination path, if necessary. (The default is C:\Formover).
- 6 Click **Save**. The name appears on the **Overlay List** box.
- 7 Click **OK** or **Yes** to finish creating.
The file is not printed. Instead it is stored on your computer hard disk drive.

NOTE: The overlay document size must be the same as the documents you print with the overlay. Do not create an overlay with a watermark.

Using a Page Overlay

After an overlay has been created, it is ready to be printed with your document. To print an overlay with a document:

- 1 Create or open the document you want to print.
- 2 To change the print settings from your software application, access printer properties. See "Printing a Document" on page 14.
- 3 Click the **Extras** tab.
- 4 Select the desired overlay from the **Overlay** drop-down list box.
- 5 If the overlay file you want does not appear in the **Overlay** list, click **Edit** button and **Load Overlay**, and select the overlay file.

If you have stored the overlay file you want to use in an external source, you can also load the file when you access the **Load Overlay** window.

After you select the file, click **Open**. The file appears in the **Overlay List** box and is available for printing. Select the overlay from the **Overlay List** box.

- 6 If necessary, click **Confirm Page Overlay When Printing**. If this box is checked, a message window appears each time you submit a document for printing, asking you to confirm your wish to print an overlay on your document.
If this box is not checked and an overlay has been selected, the overlay automatically prints with your document.
- 7 Click **OK** or **Yes** until printing begins.
The selected overlay downloads with your print job and prints on your document.

NOTE: The resolution of the overlay document must be the same as that of the document you will print with the overlay.

Deleting a Page Overlay

You can delete page overlays that you no longer use.

- 1 In the printer properties window, click the **Extras** tab.
- 2 Click the **Edit** button in the **Overlay** section.
- 3 Select the overlay you want to delete from the **Overlay List** box.
- 4 Click **Delete Overlay**.
- 5 When a confirming message window appears, click **Yes**.
- 6 Click **OK** until you exit the Print window.

4 Using Windows PostScript Driver

If you want to use the PostScript driver provided with your system CD-ROM to print a document.

PPDs, in combination with the PostScript driver, access printer features and allow the computer to communicate with the printer. An installation program for the PPDs is provided on the supplied software CD-ROM.

Printer Settings

You can use the printer properties window, which allows you to access all of the printer options you need when using your printer. When the printer properties are displayed, you can review and change the settings needed for your print job.

Your printer properties window may differ, depending on your operating system. This Software User's Guide shows the Properties window for Windows XP.

Your printer driver **Properties** window that appears in this User's Guide may differ depending on the printer in use.

NOTES:

- Most Windows applications will override settings you specify in the printer driver. Change all print settings available in the software application first, and change any remaining settings using the printer driver.
 - The settings you change remain in effect only while you are using the current program. **To make your changes permanent**, make them in the Printers folder.
 - The following procedure is for Windows XP. For other Windows OS, refer to the corresponding Windows User's Guide or online help.
 1. Click the Windows **Start** button.
 2. Select **Printers and Faxes**.
 3. Select **your printer driver icon**.
 4. Right-click on the printer driver icon and select **Printing Preferences**.
 5. Change the settings on each tab, click OK.
-

Advanced

You can use advanced settings by clicking the **Advanced** button.

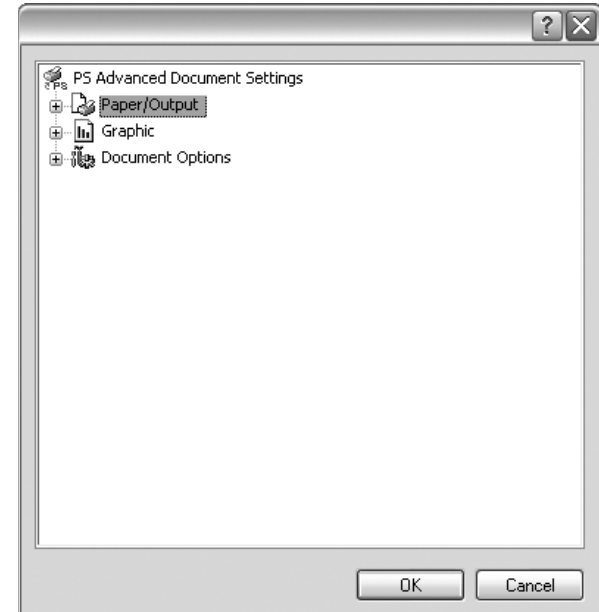

- **Paper/Output** this option allows you to select the size of the paper loaded in the tray.
- **Graphic** this option allows you to adjust the print quality for your specific printing needs.
- **Document Options** this options allow you to set the PostScript options or printer features.

Using Help

You can click  from the upper right corner of the window, and then click on any setting.

5 Using Direct Printing Utility

This chapter explains how to use Direct Printing Utility to print PDF files without having to open the files.

CAUTION

- You can not print PDF files that are restricted to print. Deactivate the printing restriction feature, and retry printing.
- You can not print PDF files that are restricted by a password. Deactivate the password feature, and retry printing.
- Depending on how a PDF file was created, it may not be able to be printed using the **Direct Printing Utility** program.
- Depending on the installation of Hard Disk on your printer, PDF files can or can not be printed using the **Direct Printing Utility** program.
- The **Direct Printing Utility** program supports PDF version 1.4 and below. For a higher version, you must open the file to print it.

Overview Direct Printing Utility

Direct Printing Utility is a program that sends a PDF file directly to your printer without having to open the file. It sends data through the Windows spooler using the port of the printer driver. It only supports PDF format.

To installing this program, you should select **Custom installation** and put a check mark in this program when you install the printer driver.

Printing

There are several ways you can print using Direct Printing Utility.

From the Direct Printing Utility window

- 1** From the **Start** menu select **Programs** or **All Programs** → **Direct Printing Utility** → **Direct Printing Utility**.
Or, double-click the Direct Printing Utility shortcut icon on your desk top.
The Direct Printing Utility window opens.
- 2** Select the printer you will use in the Select Printer section and click **Browse**.
- 3** Select the PDF file you will print and click **Open**.
The PDF file is added in the Select Files section.
- 4** Customize the printer settings for your needs. See the next column.
- 5** Click **Print**.
The selected PDF file is sent to the printer.

Using the shortcut icon

- 1** Select the PDF file you will print and by dragging drop it to the Direct Printing Utility shortcut icon on your desk top.
The selected PDF file is sent to the default printer.

NOTE : If the default printer does not support Direct Printing Utility, the message window alerting you to select the appropriate printer opens. Select the appropriate printer in the Select Printer section.

- 2** Customize the printer settings for your needs.
- 3** Click **Print**.
The selected PDF file is sent to the printer.

Using the right-click menu

- 1** Right-click on the PDF file you will print and select **Direct Printing**.
The Direct Printing Utility window opens with the PDF file is added.
- 2** Select the printer you will use.
- 3** Customize the printer settings for your needs. See the below part.
- 4** Click **Print**.
The selected PDF file is sent to the printer.

6 Sharing the Printer Locally

You can connect the printer directly to a selected computer, which is called "host computer," on the network.

The following procedure is for Windows XP. For other Windows OS, refer to the corresponding Windows User's Guide or online help.

NOTE:

- Check the Operating System(s) that are compatible with your printer. Please refer to the OS Compatibility section of Printer Specifications in your Printer User's Guide.
 - If you need to know the exact name of your printer, you can check the supplied CD-ROM.
-

Setting Up a Host Computer

- 1 Start Windows.
- 2 From the **Start** menu select **Printers and Faxes**.
- 3 Double-click **your printer driver icon**.
- 4 From the **Printer** menu, select **Sharing**.
- 5 Check the **Share this printer** box.
- 6 Fill in the **Shared Name** field, and then click **OK**.

Setting Up a Client Computer

- 1 Right-click the Windows **Start** button and select **Explore**.
- 2 Select **My Network Places** and then right-click **Search for Computers**.
- 3 Fill in the IP address of host computer in **Computer name** field, and click **Search**. (In case host computer requires **User name** and **Password**, fill in User ID and password of host computer account.)
- 4 Double-click **Printers and Faxes**.
- 5 Right-click printer driver icon, select **Connect**.
- 6 Click **Yes**, if the installation confirm message appears.

7 Scanning

Scanning with your machine lets you turn pictures and text into digital files on your computer. Then you can fax or e-mail the files, display them on your web site or use them to create projects that you can print using SmarThru software or the WIA driver.

This chapter includes:

- **Scanning Using SmarThru Office**
- **Scanning Process with TWAIN-enabled Software**
- **Scanning Using the WIA Driver**

NOTE:

- *Check the Operating System(s) that are compatible with your printer. Please refer to the OS Compatibility section of Printer Specifications in your Printer User's Guide.*
- *You can check your printer name in the supplied CD-ROM.*
- *The maximum resolution that can be achieved depends upon various factors, including computer speed, available disk space, memory, the size of the image being scanned, and bit depth settings. Thus, depending on your system and what you are scanning, you may not be able to scan at certain resolutions, especially using enhanced dpi.*

Scanning Using SmarThru Office

SmarThru Office is the accompanying software for your machine. You can use **SmarThru Office** to scan images or documents from local or network scanners.

Using SmarThru Office

Follow these steps to start scanning using the **SmarThru Office**:

- 1** Make sure that your machine and computer are turned on and properly connected to each other.
- 2** Place your photograph or page on the document glass or DADF (or ADF).
- 3** Once you have installed **SmarThru Office**, you will see the **SmarThru Office** icon on your desktop. Double-click the **SmarThru Office** icon.



Double-click this icon.

The **SmarThru Office** window opens.

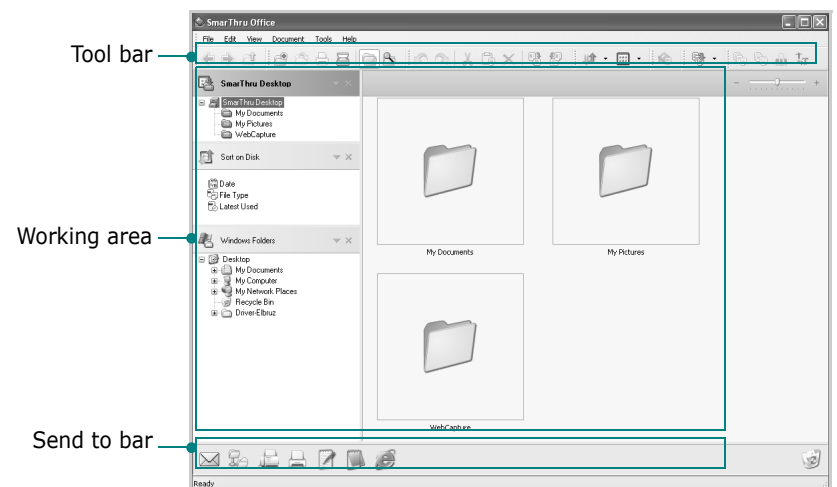

- **Tool bar:** Allows you to use shortcut icons which activate the certain functions such as **Scan**, **Search**, etc.

•Working area

- **SmarThru Desktop:** Created within the standard Windows folder My Documents.
- **Sort on Disk:** Files of the folders which are not indexed will not be displayed in the **Sort on Disk** section. Sort type are Date, File Types, Latest Used. To add a folder for indexing, press **Edit** menu → **Preferences** → **Index**.
It may take longer time to show the added file folders according to the computer performance and the number of added file folders.

NOTE:

- To do indexing and searching the PDF format file, you must install Adobe Acrobat Reader 7.0.5 or higher.
- You can use indexing and searching functions using **SmarThru Office** supported by Microsoft Indexing Service. This service is supported in Windows 2000 or above.

- **Windows Folders:** Allow user to navigate through all the user's files and folders.
- The right panel: Reflects the content of a selected folder.
- Send to bar:** Run the corresponding application directly. Drag and drop selected files to the appropriate application button.
 - **Send by E-mail:** To send documents by E-mail while working within the **SmarThru Office**. To send scanned images or documents by e-mail, you must have a mail client program, like Outlook Express, which has been set up with your e-mail account.
 - **Send by FTP:** To upload a document file to server while working within the **SmarThru Office**.
 - **Send by Fax:** To send documents by Local or Network fax machine while working within the **SmarThru Office**.

4 Click **Scan** on the tool bar of **SmarThru Office** window.

Adjust the scan settings.

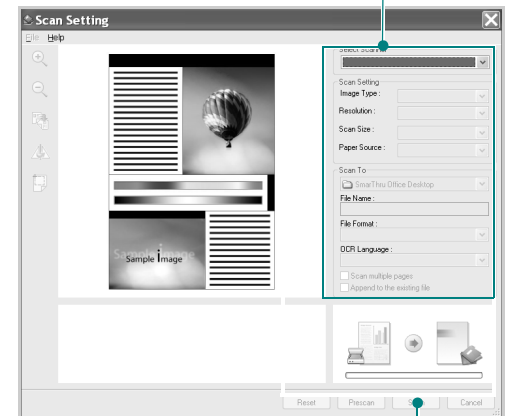

Click to start scanning.

NOTE:

- In Windows XP operating system, you can use **SmarThru Office** launcher, which is on the right end of taskbar, to open the **Scan Setting** window easily.



- In other operating systems beside Windows XP, click the SmarThru icon  in the tray area of the windows taskbar to activate the **SmarThru Office** launcher.



Scan Setting lets you use the following services:

- Select Scanner:** Select the Local or Network scanner.
 - Local Scan: After scanning with parallel port or USB port, you can store the scanned output in image or document file.
 - Network Scan: After scanning via network, you can store the scanned output in JPEG, TIFF, or pdf file. To use network scanner, your computer should install the **Scan Manager** and register the scanner within that program. Refer to Scanning chapter in user's guide.
- Scan Settings:** Allows you to customize settings for Image type, Resolution, Scan Size, Paper Source.
- Scan To:** Allows you to customize settings for File Name, File Format, OCR Language.

5 To start scanning, click **Scan**.

NOTE: If you want to cancel the scan job, click **Cancel**.

Uninstalling SmarThru Office

NOTE: Before beginning uninstallation, ensure that all applications are closed on your computer.

- 1 From the **Start** menu, select **Programs**.
- 2 Select **SmarThru Office**, and then select **Uninstall SmarThru Office**.
- 3 When your computer asks you to confirm, read the statement and click **OK**.
- 4 Click **Finish**.

Using Onscreen Help File

For more information about SmarThru, click  at the top right corner of the window. The SmarThru Help window opens and allows you to view onscreen help supplied on the SmarThru program.

Scanning Process with TWAIN-enabled Software

If you want to scan documents using other software, you will need to use TWAIN-compliant software, such as Adobe Photoshop. The first time you scan with your machine, select it as your TWAIN source in the application you use.

The basic scanning process involves a number of steps:

- 1 Make sure that your machine and computer are turned on and properly connected to each other.
- 2 Load the document(s) face up into the DADF.
OR
Place a single document face down on the document glass.
- 3 Open an application, such as Photoshop.
- 4 Open the TWAIN window and set the scan options.
- 5 Scan and save your scanned image.

NOTE: You need to follow the program's instructions for acquiring an image. Please refer to the user's guide of the application.

Scanning Using the WIA Driver

Your machine also supports the Windows Image Acquisition (WIA) driver for scanning images. WIA is one of the standard components provided by Microsoft® Windows® XP and works with digital cameras and scanners. Unlike the TWAIN driver, the WIA driver allows you to scan and easily manipulate images without using additional software.

NOTE: The WIA driver works only on Windows XP/Vista with USB port.

Windows XP

- 1 Load the document(s) face up into the DADF.
OR
Place a single document face down on the document glass.
- 2 From the **Start** menu on your desktop window, select **Settings, Control Panel**, and then **Scanners and Cameras**.
- 3 Double click **your scanner driver** icon. The Scanner and Camera Wizard launches.
- 4 Choose your scanning preferences and click **Preview** to see how your preferences affect the picture.
- 5 Click **Next**.
- 6 Enter a picture name, and select a file format and destination to save the picture.
- 7 Follow the on-screen instructions to edit the picture after it is copied to your computer.

Windows Vista

- 1 Load the document(s) face up into the DADF.
OR
Place a single document face down on the document glass.
- 2 Click **Start** → **Control Panel** → **Hardware and Sound** → **Scanners and Cameras**.
- 3 Click on **Scan a document or picture**. Then **Windows Fax and Scan** application is opened automatically.

NOTE:

- To view scanners, user can click on **View scanners and cameras**.
- If there is not **Scan a document or picture**, open the MS paint program and click **From Scanner or Camera...** on **File** menu.

- 4 Click **New Scan** and then scan driver is opened.
- 5 Choose your scanning preferences and click **Preview** to see your preferences affect the picture.
- 6 Click **Scan**.

NOTE: If you want to cancel the scan job, press the Cancel button on the Scanner and Camera Wizard.

8 Using Smart Panel

Smart Panel is a program that monitors and informs you of the status of the printer, and allows you to customize the printer's settings. Smart Panel is installed automatically when you install the printer software.

NOTE:

- To use this program, you need:
 - Windows. To check for windows operating system(s) that are compatible with your printer, refer to Printer Specifications in your Printer User's Guide.
 - Mac OS X 10.3 or higher
 - Linux. To check for Linux systems that are compatible with your printer, refer to Printer Specifications in your Printer User's Guide.
 - Internet Explorer version 5.0 or higher for flash animation in HTML Help.
- If you need to know the exact name of your printer, you can check the supplied CD-ROM.

Understanding Smart Panel

If an error occurs while printing, Smart Panel appears automatically, showing the error.

You can also launch Smart Panel manually. Double-click the Smart Panel icon on the Windows task bar (in Windows), or Notification Area (in Linux). You can also click it on the status bar (in Mac OS X).

Double-click this icon in Windows.

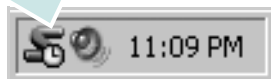

Click this icon in Mac OS X.



Click this icon in Linux.



If you are a Windows user, from the **Start** menu, select **Programs** or **All Programs** → **your printer driver name** → **Smart Panel**.

NOTE:

- If you have already installed more than one printer, first select the printer model you want in order to use the corresponding Smart Panel. Right-click (in Windows or Linux) or click (in Mac OS X) the Smart Panel icon and select **your printer name**.
- The Smart Panel window and its contents shown in this Software User's Guide may differ depending on the printer or Operating System in use.

The Smart Panel program displays the current status of the printer, the level of toner remaining in the toner cartridge(s) and various other information. You can also change settings.

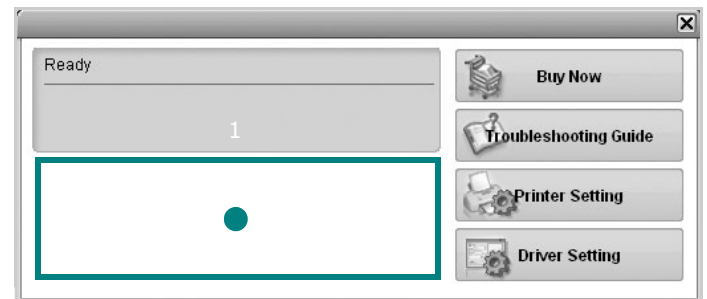

● Toner Level

You can view the level of toner remaining in the toner cartridge(s). The printer and the number of toner cartridge(s) shown in the above window may differ depending on the printer in use. Any printers do not have this feature.

Troubleshooting Guide

You can view Help to solve problems.

Printer Setting

You can configure various printer settings in the Printer Settings Utility window. Any printers do not have this feature.

NOTE: If you connect your printer to a network, the **SyncThru Web Service** window appears instead of the Printer Settings Utility window.

Driver Setting (Only for Windows)

You can use the printer properties window, which allows you to access all of the printer options you need for using your printer. For details, See "Printer Settings" on page 15.

Opening the Troubleshooting Guide

Using the troubleshooting guide, you can view solutions for error status problems.

Right-click (in Windows or Linux) or click (in Mac OS X) the Smart Panel icon and select **Troubleshooting Guide**.

Using Printer Settings Utility

Using the Printer Settings Utility, you can configure and check print settings.

- 1 Right-click (in Windows or Linux) or click (in Mac OS X) the Smart Panel icon and select **Printer Setting**.
- 2 Change the settings.
- 3 To send the changes to the printer, click the **Apply** button.

NOTES: If your printer is connected to a network, the **SyncThru Web Service** window appears instead of the Printer Settings Utility window.

Using Onscreen Help File

For more information about **Printer Settings Utility**, click  .

Changing the Smart Panel Program Settings

Right-click (in Windows or Linux) or click (in Mac OS X) the Smart Panel icon and select **Options**.

The following window opens.

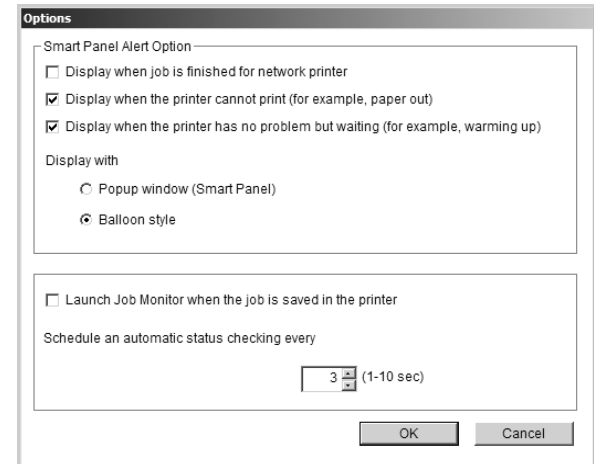

- **Display when job is finished for network printer:** The computer shows the Smart Panel popup window or balloon when your job is complete in Windows. *(Linux do not support network environments)*
- **Display when the printer cannot print (for example, paper out):** The computer shows the Smart Panel popup window or balloon when an error occurs during printing.
- **Display when the printer has no problem but waiting (for example, warming up):** The computer shows the Smart Panel popup window or balloon while waiting or warming up the machine.
- **Display when error occurs during printing:** The computer shows the Smart Panel popup window or balloon when an error occurs during printing.
- **Display with:** You can select how the computer shows you a message. If you select **Popup window (smart panel)**, the message appears in the Smart Panel popup window in Windows.
- **Launch Job Monitor when the job is saved in the printer:** If you store print jobs on the printer's hard disk, the computer opens the Job Monitor window in Windows. *(Only for Windows network-supported printers with built-in hard disks.)*
- **Schedule an automatic status checking every:** The computer updates the printer status regularly. Setting the value close to 1 second causes the computer to check the printer status more frequently, thereby allowing a faster response to any printer error.

9 Using Your Printer in Linux

You can use your machine in a Linux environment.

This chapter includes:

- **Getting Started**
- **Installing the Unified Linux Driver**
- **Using SetIP program**
- **Using the Unified Driver Configurator**
- **Configuring Printer Properties**
- **Printing a Document**
- **Scanning a Document**

Getting Started

The supplied CD-ROM provides you with the Unified Linux Driver package for using your machine with a Linux computer.

Unified Linux Driver package contains printer and scanner drivers, providing the ability to print documents and scan images. The package also delivers powerful applications for configuring your machine and further processing of the scanned documents.

After the driver is installed on your Linux system, the driver package allows you to monitor a number of machine devices via fast ECP parallel ports and USB simultaneously.

The acquired documents can then be edited, printed on the same local or network machine devices, sent by e-mail, uploaded to an FTP site, or transferred to an external OCR system.

The Unified Linux Driver package is supplied with a smart and flexible installation program. You don't need to search for additional components that might be necessary for the Unified Linux Driver software: all required packages will be carried onto your system and installed automatically; this is possible on a wide set of the most popular Linux clones.

Installing the Unified Linux Driver

Installing the Unified Linux Driver

- 1 Make sure that you connect your machine to your computer. Turn both the computer and the machine on.
- 2 When the Administrator Login window appears, type in *root* in the Login field and enter the system password.

NOTE: You must log in as a super user (*root*) to install the printer software. If you are not a super user, ask your system administrator.

- 3 Insert the printer software CD-ROM. The CD-ROM will automatically run.

If the CD-ROM does not automatically run, click the  icon at the bottom of the desktop. When the Terminal screen appears, type in:

```
If the CD-ROM is secondary master and the location to
mount is /mnt/cdrom,
[root@localhost root]#mount -t iso9660 /dev/hdc /mnt/
cdrom
[root@localhost root]#cd /mnt/cdrom/Linux
[root@localhost root]#./install.sh
```

If you still failed to run the CD-ROM, type the followings in sequence:

```
[root@localhost root]#umount /dev/hdc
[root@localhost root]#mount -t iso9660 /dev/hdc /mnt/
cdrom
```

NOTE: The installation program runs automatically if you have an autorun software package installed and configured.

- 4 When the welcome screen appears, click **Next**.



- 5 When the installation is complete, click **Finish**.



The installation program has added the Unified Driver Configurator desktop icon and Unified Driver group to the system menu for your convenience. If you have any difficulties, consult the onscreen help that is available through your system menu or can otherwise be called from the driver package windows applications, such as **Unified Driver Configurator** or **Image Manager**.

NOTE: Installing the driver in the text mode:

- If you do not use the graphical interface or have failed the driver installation, you have to use the driver in the text mode.
- Follow the step 1 to 3, then type `[root@localhost Linux]# ./install.sh`, then follow the instruction on the terminal screen. Then the installation completes.
- When you want to uninstall the driver, follow the installation instruction above, but type `[root@localhost Linux]# ./uninstall.sh` on the terminal screen.

Uninstalling the Unified Linux Driver

- 1 When the Administrator Login window appears, type in `root` in the Login field and enter the system password.

NOTE: You must log in as a super user (`root`) to uninstall the printer software. If you are not a super user, ask your system administrator.

- 2 Insert the printer software CD-ROM. The CD-ROM will automatically run.

If the CD-ROM does not automatically run, click the  icon at the bottom of the desktop. When the Terminal screen appears, type in:

If the CD-ROM is secondary master and the location to mount is `/mnt/cdrom`,

```
[root@localhost root]# mount -t iso9660 /dev/hdc /mnt/cdrom
```

```
[root@localhost root]# cd /mnt/cdrom/Linux
```

```
[root@localhost root]# ./uninstall.sh
```

NOTE: The installation program runs automatically if you have an autorun software package installed and configured.

- 3 Click **Uninstall**.
- 4 Click **Next**.

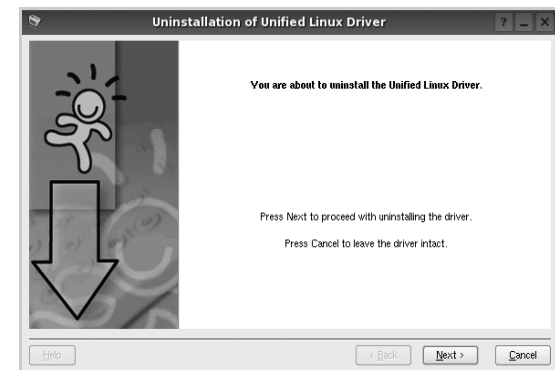

- 5 Click **Finish**.

Using SetIP program

This program is for the network IP setting using the MAC address which is the hardware serial number of the network printer card or interface. Especially, it is for the network administrator to set several network IPs at the same time.

You can only use SetIP program when your machine is connected to a network.

SetIP program should be automatically installed during the printer driver installation.

Starting the program

- 1 Print the machine's network information report which includes your machine's MAC address.
- 2 Open the `/opt/Samsung/mfp/share/utils/`.
- 3 Double click the **SetIPApplet.html** file.
- 4 Click  in the SetIP window to open the TCP/IP configuration window.
- 5 Enter the network card's MAC address, IP address, subnet mask, default gateway, and then click **Apply**.

NOTE: when you enter the MAC address, enter it without colon(:).

- 6 The machine prints the network information. Confirm all the settings are correct.
- 7 Close the **SetIP** program.

Using the Unified Driver Configurator

Unified Linux Driver Configurator is a tool primarily intended for configuring Printer or MFP devices. Since an MFP device combines the printer and scanner, the Unified Linux Driver Configurator provides options logically grouped for printer and scanner functions. There is also a special MFP port option responsible for the regulation of access to an MFP printer and scanner via a single I/O channel.

After installing the Unified Linux driver, the Unified Linux Driver Configurator icon will automatically be created on your desktop.

Opening the Unified Driver Configurator

- 1 Double-click **Unified Driver Configurator** on the desktop.
You can also click the Startup Menu icon and select **Samsung Unified Driver** and then **Unified Driver Configurator**.
- 2 Press each button on the Modules pane to switch to the corresponding configuration window.

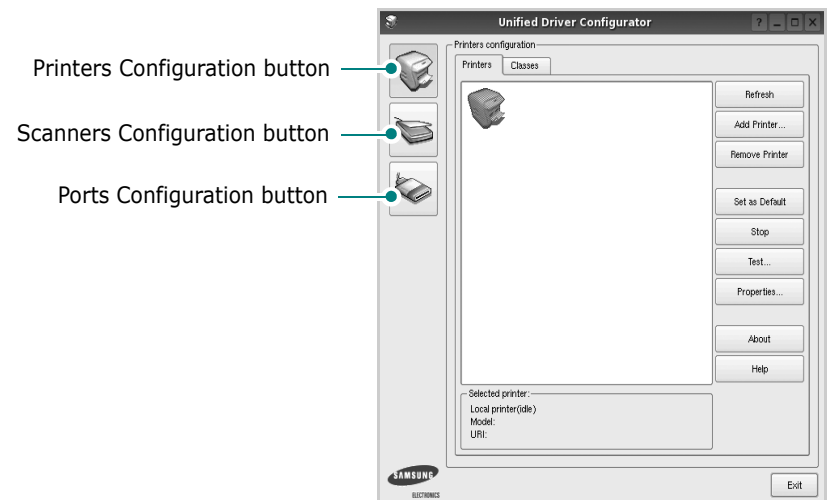

Printers Configuration

Printers configuration has the two tabs: **Printers** and **Classes**.

Printers Tab

You can see the current system's printer configuration by clicking on the printer icon button on the left side of the Unified Driver Configurator window.

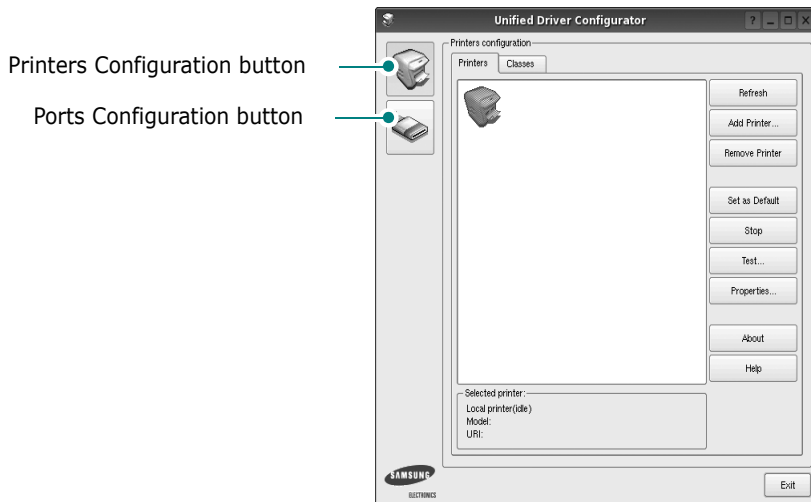

Printers Configuration button
Ports Configuration button

- 3 You can use the onscreen help by clicking **Help**.
After changing the configurations, click **Exit** to close the Unified Driver Configurator.

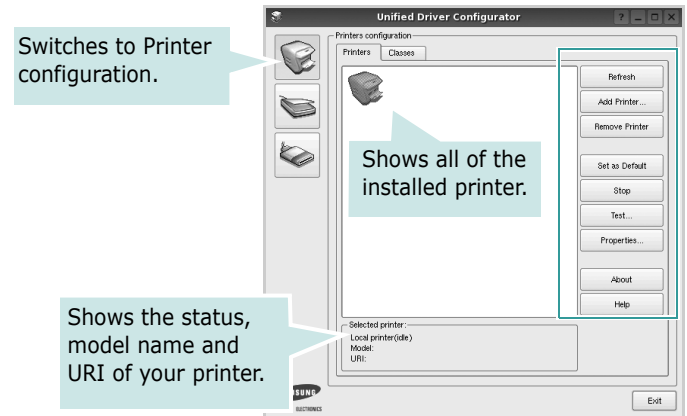

You can use the following printer control buttons:

- **Refresh:** renews the available printers list.
- **Add Printer:** allows you to add a new printer.
- **Remove Printer:** removes the selected printer.
- **Set as Default:** sets the current printer as a default printer.
- **Stop/Start:** stops/starts the printer.
- **Test:** allows you to print a test page to check if the machine is working properly.
- **Properties:** allows you to view and change the printer properties. For details, see page 37.

Classes Tab

The Classes tab shows a list of available printer classes.

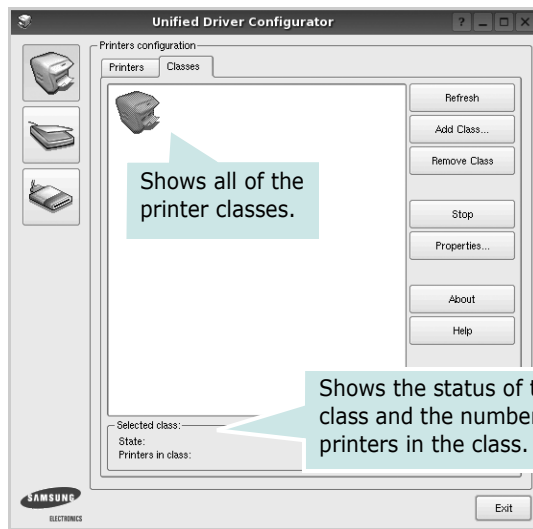

- **Refresh** : Renews the classes list.
- **Add Class...** : Allows you to add a new printer class.
- **Remove Class** : Removes the selected printer class.

Scanners Configuration

In this window, you can monitor the activity of scanner devices, view a list of installed MFP devices, change device properties, and scan images.

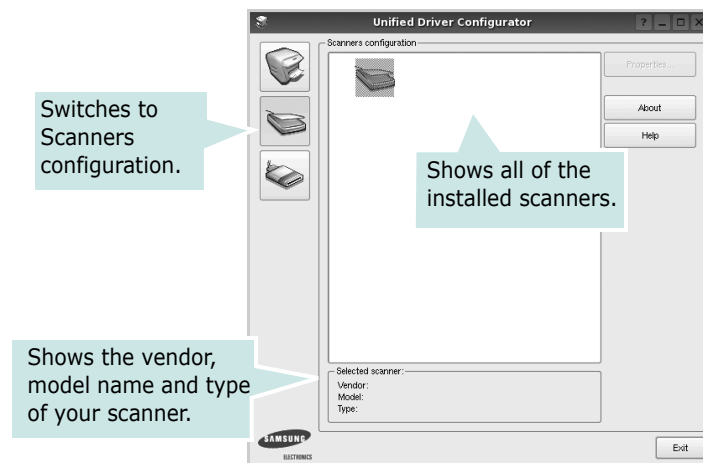

- **Properties...** : Allows you to change the scan properties and scan a document. See page 38.

Ports Configuration

In this window, you can view the list of available ports, check the status of each port and release a port that is stalled in busy state when its owner is terminated for any reason.

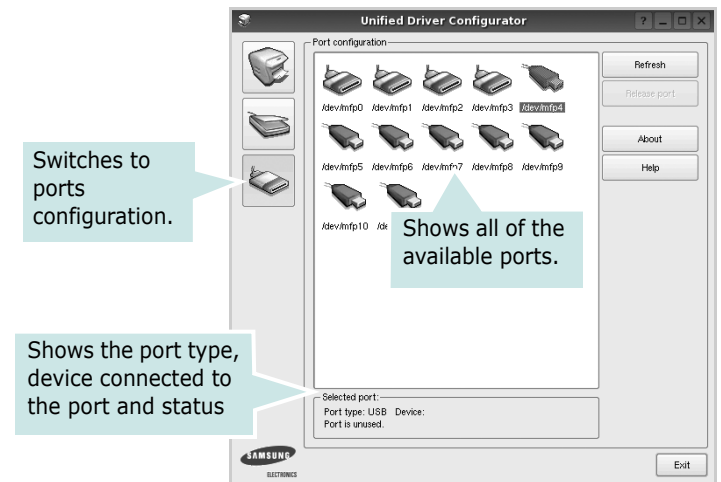

- **Refresh** : Renews the available ports list.
- **Release port** : Releases the selected port.

Sharing Ports Between Printers and Scanners

Your machine may be connected to a host computer via the parallel port or USB port. Since the MFP device contains more than one device (printer and scanner), it is necessary to organize proper access of "consumer" applications to these devices via the single I/O port.

The Unified Linux Driver package provides an appropriate port sharing mechanism that is used by printer and scanner drivers. The drivers address their devices via so-called MFP ports. The current status of any MFP port can be viewed via the Ports Configuration. The port sharing prevents you from accessing one functional block of the MFP device, while another block is in use.

When you install a new MFP device onto your system, it is strongly recommended you do this with the assistance of an Unified Driver Configurator. In this case you will be asked to choose I/O port for the new device. This choice will provide the most suitable configuration for MFP's functionality. For MFP scanners I/O ports are being chosen by scanner drivers automatically, so proper settings are applied by default.

Configuring Printer Properties

Using the properties window provided by the Printers configuration, you can change the various properties for your machine as a printer.

- 1 Open the Unified Driver Configurator.
If necessary, switch to Printers configuration.
- 2 Select your machine on the available printers list and click **Properties**.
- 3 The Printer Properties window opens.

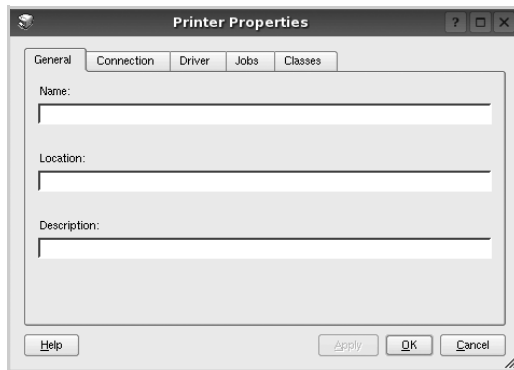

The following five tabs display at the top of the window:

- **General:** allows you to change the printer location and name. The name entered in this tab displays on the printer list in Printers configuration.
 - **Connection:** allows you to view or select another port. If you change the printer port from USB to parallel or vice versa while in use, you must re-configure the printer port in this tab.
 - **Driver:** allows you to view or select another printer driver. By clicking **Options**, you can set the default device options.
 - **Jobs:** shows the list of print jobs. Click **Cancel job** to cancel the selected job and select the **Show completed jobs** check box to see previous jobs on the job list.
 - **Classes:** shows the class that your printer is in. Click **Add to Class** to add your printer to a specific class or click **Remove from Class** to remove the printer from the selected class.
- 4 Click **OK** to apply the changes and close the Printer Properties Window.

Printing a Document

Printing from Applications

There are a lot of Linux applications that you are allowed to print from using Common UNIX Printing System (CUPS). You can print on your machine from any such application.

- 1 From the application you are using, select **Print** from the **File** menu.
- 2 Select **Print** directly using **lpr**.
- 3 In the LPR GUI window, select the model name of your machine from the Printer list and click **Properties**.

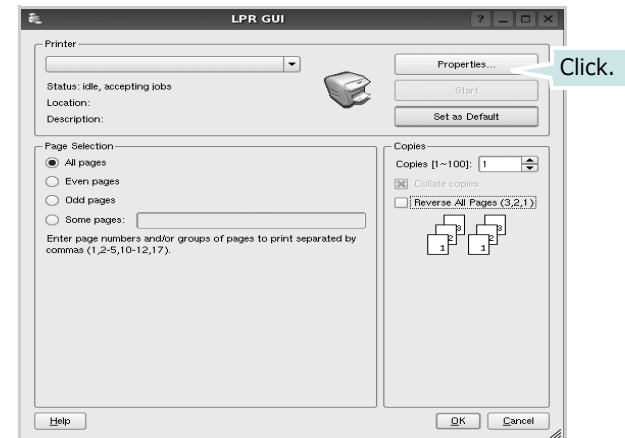

- 4 Change the printer and print job properties.

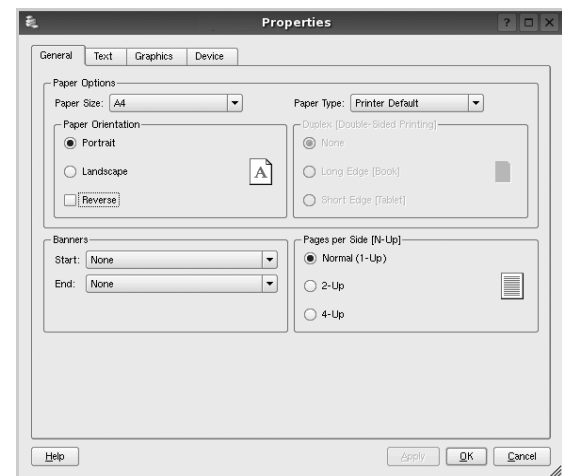

The following four tabs display at the top of the window.

- General** - allows you to change the paper size, the paper type, and the orientation of the documents, enables the duplex feature, adds start and end banners, and changes the number of pages per sheet.
- Text** - allows you to specify the page margins and set the text options, such as spacing or columns.
- Graphics** - allows you to set image options that are used when printing images/files, such as color options, image size, or image position.
- Device**: allows you to set the print resolution, paper source, and destination.

- 5 Click **Apply** to apply the changes and close the Properties window.
- 6 Click **OK** in the LPR GUI window to start printing.
- 7 The Printing window appears, allowing you to monitor the status of your print job.

To abort the current job, click **Cancel**.

Printing Files

You can print many different types of files on the Samsung machine device using the standard CUPS way - directly from the command line interface. The CUPS lpr utility allows you do that. But the drivers package replaces the standard lpr tool by a much more user-friendly LPR GUI program.

To print any document file:

- 1 Type `lpr <file_name>` from the Linux shell command line and press **Enter**. The LPR GUI window appears.
When you type only `lpr` and press **Enter**, the Select file(s) to print window appears first. Just select any files you want to print and click **Open**.
- 2 In the LPR GUI window, select your printer from the list, and change the printer and print job properties.
For details about the properties window, see page 37.
- 3 Click **OK** to start printing.

Scanning a Document

You can scan a document using the Unified Driver Configurator window.

- 1 Double-click the Unified Driver Configurator on your desktop.
- 2 Click the  button to switch to Scanners Configuration.
- 3 Select the scanner on the list.



When you have only one MFP device and it is connected to the computer and turned on, your scanner appears on the list and is automatically selected.

If you have two or more scanners attached to your computer, you can select any scanner to work at any time. For example, while acquisition is in progress on the first scanner, you may select the second scanner, set the device options and start the image acquisition simultaneously.

- 4 Click **Properties**.
- 5 Load the document to be scanned face up into the ADF (Automatic Document Feeder) or face down on the document glass.
- 6 Click **Preview** in the Scanner Properties window.

The document is scanned and the image preview appears in the Preview Pane.

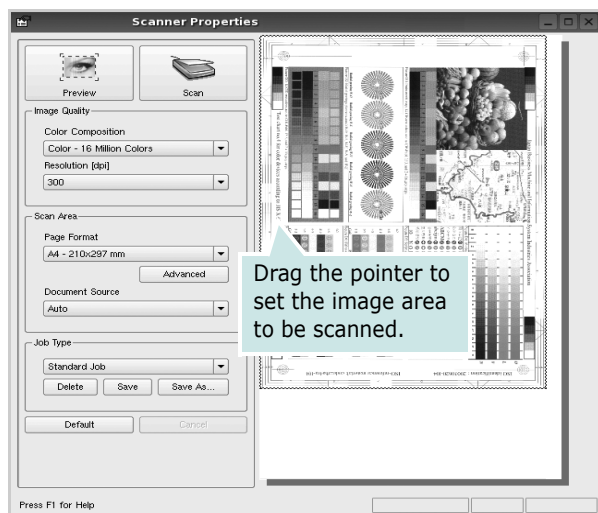

- 7 Change the scan options in the Image Quality and Scan Area sections.

- Image Quality:** allows you to select the color composition and the scan resolution for the image.

- Scan Area:** allows you to select the page size. The **Advanced** button enables you to set the page size manually.

If you want to use one of the preset scan option settings, select from the Job Type drop-down list. For details about the preset Job Type settings, see page 39.

You can restore the default setting for the scan options by clicking **Default**.

- 8 When you have finished, click **Scan** to start scanning.

The status bar appears on the bottom left of the window to show you the progress of the scan. To cancel scanning, click **Cancel**.

- 9 The scanned image appears in the new Image Manager tab.

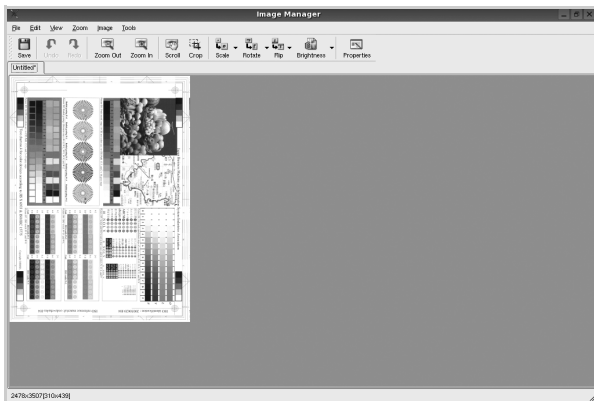

If you want to edit the scanned image, use the toolbar. For further details about editing an image, see page 39.

- 10 When you are finished, click **Save** on the toolbar.

- 11 Select the file directory where you want to save the image and enter the file name.

- 12 Click **Save**.

Adding Job Type Settings

You can save your scan option settings to retrieve for a later scanning.

To save a new Job Type setting:

- 1 Change the options from the Scanner Properties window.
- 2 Click **Save As**.
- 3 Enter the name for your setting.
- 4 Click **OK**.

Your setting is added to the Saved Settings drop-down list.

To save a Job Type setting for the next scan job:

- 1 Select the setting you want to use from the Job Type drop-down list.
- 2 The next time you open the Scanner Properties window, the saved setting is automatically selected for the scan job.

To delete a Job Type setting:

- 1 Select the setting you want to delete from the Job Type drop-down list.
- 2 Click **Delete**.







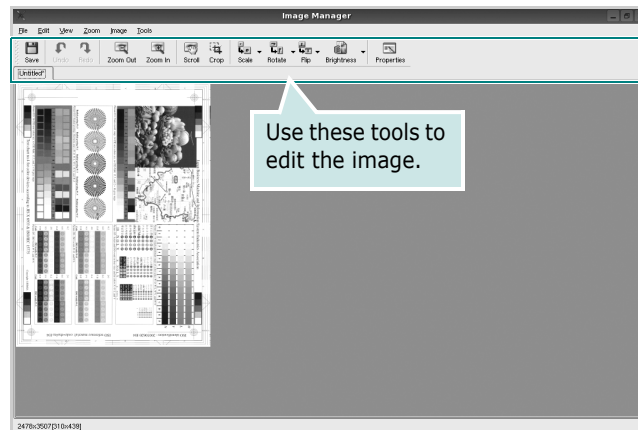





The setting is deleted from the list

Using the Image Manager

The Image Manager application provides you with menu commands and tools to edit your scanned image.



You can use the following tools to edit the image:

Tools	Function
 Save	Saves the image.
 Undo	Cancels your last action.
 Redo	Restores the action you canceled.
 Scroll	Allows you to scroll through the image.
 Crop	Crops the selected image area.
 Zoom Out	Zooms the image out.
 Zoom In	Zooms the image in.
 Scale	Allows you to scale the image size; you can enter the size manually, or set the rate to scale proportionally, vertically, or horizontally.
 Rotate	Allows you to rotate the image; you can select the number of degrees from the drop-down list.
 Flip	Allows you to flip the image vertically or horizontally.
 Effect	Allows you to adjust the brightness or contrast of the image, or to invert the image.
 Properties	Shows the properties of the image.

For further details about the Image Manager application, refer to the onscreen help.

10 Using Your Printer with a Macintosh

Your printer supports Macintosh systems with a built-in USB interface or 10/100 Base-TX network interface card. When you print a file from a Macintosh computer, you can use the driver by installing the PPD file.

NOTE: *Some printers do not support a network interface. Make sure that your printer supports a network interface by referring to Printer Specifications in your Printer User's Guide.*

This chapter includes:

- **Installing Software**
- **Uninstalling software**
- **Using SetIP program**
- **Setting Up the Printer**
- **Printing**
- **Scanning**

Installing Software

The CD-ROM that came with your printer provides you with the PPD file that allows you to use the CUPS driver or Apple LaserWriter driver (*only available when you use a printer which supports the PostScript driver*), for printing on a Macintosh computer.

Also, it provides you with the Twain driver for scanning on a Macintosh computer.

- 1** Make sure that you connect your printer to the computer. Turn on your computer and printer.
- 2** Insert the CD-ROM which came with your printer into the CD-ROM drive.
- 3** Double-click **CD-ROM icon** that appears on your Macintosh desktop.
- 4** Double-click the **MAC_Installer** folder.
- 5** Double-click the **Installer** icon.
- 6** Enter the password and click **OK**.
- 7** The Samsung Installer window opens. Click **Continue**
- 8** Select **Easy Install** and click **Install**. **Easy Install** is recommended for most users. All components necessary for printer operations will be installed. If you select **Custom Install**, you can choose individual components to install.

- 9** The message which warns all application will close on your computer appears, Click **Continue**.

- 10** Select **Typical installation for a local printer** and then click **OK**.

NOTE: If you select **Typical installation for a network printer**, see "Using SetIP program" on page 42 after the installation is finished.

- 11** After the installation is finished, click **Quit**.

NOTE:

- If you have installed scan driver, click **Restart**.
 - After the installation is finished, see "Setting Up the Printer" on page 42
-

Uninstalling software

Uninstall is required if you are upgrading the software, or if installation fails.

- 1** Make sure that you connect your printer to the computer. Turn on your computer and printer.
- 2** Insert the CD-ROM which came with your printer into the CD-ROM drive.
- 3** Double-click **CD-ROM icon** that appears on your Macintosh desktop.
- 4** Double-click the **MAC_Installer** folder.
- 5** Double-click the **Installer** icon.
- 6** Enter the password and click **OK**.
- 7** The Installer window opens. Click **Continue**
- 8** Select **Uninstall** and click **Uninstall**.
- 9** The message which warns all application will close on your computer appears, Click **Continue**.
- 10** When the uninstallation is done, click **Quit**.

Using SetIP program

This program is for the network IP setting using the MAC address which is the hardware serial number of the network printer card or interface. Especially, it is for the network administrator to set several network IPs at the same time.

You can only use SetIP program when your machine is connected to a network.

SetIP program should be automatically installed during the printer driver installation.

NOTE: If you select **Typical installation for a network printer** during the printer driver installation, the SetIP program automatically runs after the installation. Follow the below instruction.

- 1 The certificate window appears, click **Trust**.
- 2 Print the machine's network information report which includes your machine's MAC address.
- 3 Click  in the SetIP window to open the TCP/IP configuration window.
- 4 Enter the network card's MAC address, IP address, subnet mask, default gateway, and then click **Apply**.

NOTE: when you enter the MAC address, enter it without colon(:).

- 5 The machine prints the network information. Confirm all the settings are correct.
- 6 Close the SetIP program.

Starting the program

If you want to change your network printer IP setting, follow the below instruction.

- 1 Print the machine's network information report which includes your machine's MAC address.
- 2 Open the **Library** folder → **Printers** → **Samsung** → **Your printer model name** → **SetIP**.
- 3 Double click the **SetIPApplet.html** file.
- 4 The certificate window appears, click **Trust**.
- 5 Click  in the SetIP window to open the TCP/IP configuration window.
- 6 Enter the network card's MAC address, IP address, subnet mask, default gateway, and then click **Apply**.
when you enter the MAC address, enter it without colon(:).
- 7 The machine prints the network information. Confirm all the settings are correct.
- 8 Close the SetIP program.

Setting Up the Printer

Set up for your printer will be different depending on which cable you use to connect the printer to your computer—the network cable or the USB cable.

For a Network-connected Macintosh

NOTE: *Some printers do not support a network interface. Before connecting your printer, make sure that your printer supports a network interface by referring to Printer Specifications in your Printer User's Guide.*

- 1 Follow the instructions on "Installing Software" on page 41 to install the PPD file on your computer.
- 2 Open the **Applications** folder → **Utilities**, and **Print Setup Utility**.
 - For MAC OS 10.5, open **System Preferences** from the **Applications** folder, and click **Printer & Fax**.
- 3 Click **Add** on the **Printer List**.
 - For MAC OS 10.5, press the "+" icon then a display window will pop up.
- 4 For MAC OS 10.3, select the **Rendezvous** tab.
 - For MAC OS 10.4, click **Default Browser** and find the **Bonjour**.
 - For MAC OS 10.5, click **Default** and find the **Bonjour**.
The name of your machine appears on the list. Select **SEC000xxxxxxxxxx** from the printer box, where the **xxxxxxxxxx** varies depending on your machine.
- 5 For MAC OS 10.3, if Auto Select does not work properly, select **Samsung** in **Printer Model** and **your printer name** in **Model Name**.
 - For MAC OS 10.4, if Auto Select does not work properly, select **Samsung** in **Print Using** and **your printer name** in **Model**.
 - For MAC OS 10.5, if Auto Select does not work properly, select **Select a driver to use...** and **your printer name** in **Print Using**.Your machine appears on the Printer List and is set as the default printer.
- 6 Click **Add**.

For a USB-connected

- 1** Follow the instructions on “Installing Software” on page 41 to install the PPD file on your computer.
- 2** Open the **Applications** folder → **Utilities**, and **Print Setup Utility**.
 - For MAC OS 10.5, open **System Preferences** from the **Applications** folder, and click **Printer & Fax**.
- 3** Click **Add** on the **Printer List**.
 - For MAC OS 10.5, press the “+” icon then a display window will pop up.
- 4** For MAC OS 10.3, select the **USB** tab.
 - For MAC OS 10.4, click **Default Browser** and find the USB connection.
 - For MAC OS 10.5, click **Default** and find the USB connection.
- 5** Select **your printer name**.
- 6** For MAC OS 10.3, if Auto Select does not work properly, select **Samsung** in **Printer Model** and **your printer name** in **Model Name**.
 - For MAC OS 10.4, if Auto Select does not work properly, select **Samsung** in **Print Using** and **your printer name** in **Model**.
 - For MAC OS 10.5, if Auto Select does not work properly, select **Select a driver to use...** and **your printer name** in **Print Using**.

Your machine appears on the Printer List and is set as the default printer.
- 7** Click **Add**.

Printing

NOTE:

- The Macintosh printer's properties window that appears in this User's Guide may differ depending on the printer in use. However the composition of the printer properties window is similar.
- *You can check your printer name in the supplied CD-ROM.*

Printing a Document

When you print with a Macintosh, you need to check the printer software setting in each application you use. Follow these steps to print from a Macintosh.

- 1 Open a Macintosh application and select the file you want to print.
- 2 Open the **File** menu and click **Page Setup (Document Setup** in some applications).
- 3 Choose your paper size, orientation, scaling, and other options and click **OK**.

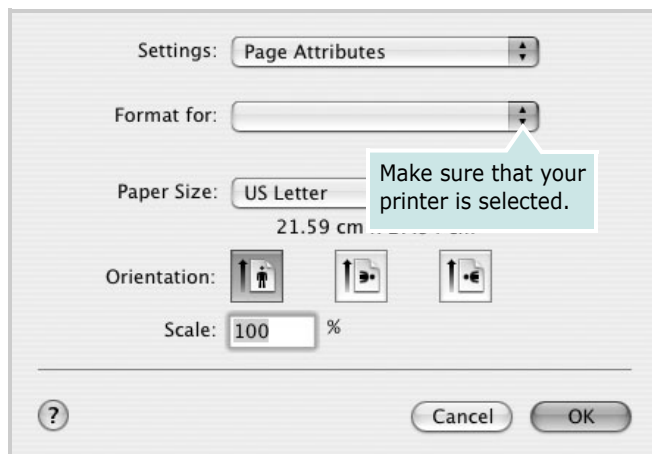

▲ Mac OS 10.3

- 4 Open the **File** menu and click **Print**.
- 5 Choose the number of copies you want and indicate which pages you want to print.
- 6 Click **Print** when you finish setting the options.

Changing Printer Settings

You can use advanced printing features when using your printer.

From your Macintosh application, select **Print** from the **File** menu. The printer name which appears in the printer properties window may differ depending on the printer in use. Except for the name, the composition of the printer properties window is similar.

NOTE: The setting options may differ depending on printers and Macintosh OS version.

Layout

The **Layout** tab provides options to adjust how the document appears on the printed page. You can print multiple pages on one sheet of paper. Select **Layout** from the **Presets** drop-down list to access the following features.

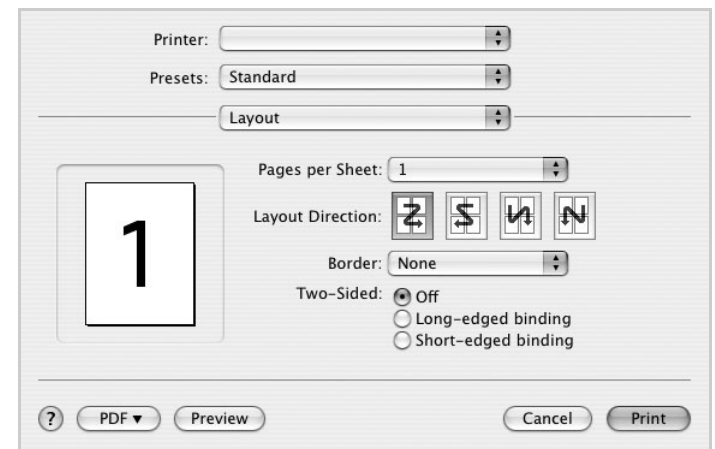

▲ Mac OS 10.4

- **Pages per Sheet:** This feature determines how many pages printed on one page. For details, see "Printing Multiple Pages on One Sheet of Paper" on the next column.
- **Layout Direction:** You can select the printing direction on a page as like the examples on UI.

Graphics

The **Graphics** tab provides options for selecting **Resolution(Quality)** and **Color Mode**. Select **Graphics** from the **Presets**' drop-down list to access the graphic features.

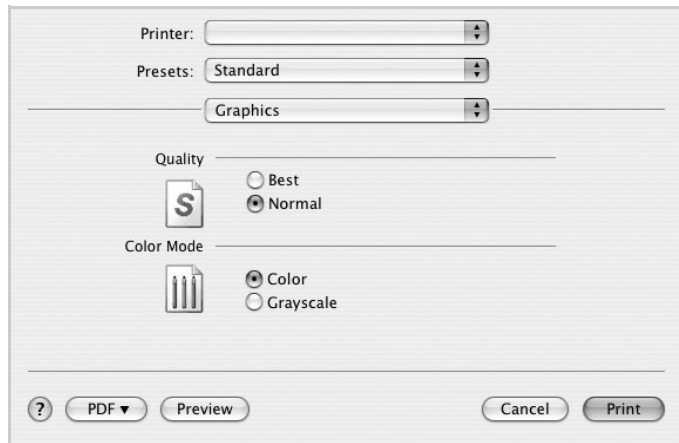

▲ Mac OS 10.4

- **Resolution(Quality)**: You can select the printing resolution. The higher the setting, the sharper the clarity of printed characters and graphics. The higher setting also may increase the time it takes to print a document.
- **Color Mode**: You can set the color options. Setting to **Color** typically produces the best possible print quality for color documents. If you want to print a color document in grayscale, select **Grayscale**.

Paper

Set **Paper Type** to correspond to the paper loaded in the tray from which you want to print. This will let you get the best quality printout. If you load a different type of print material, select the corresponding paper type.

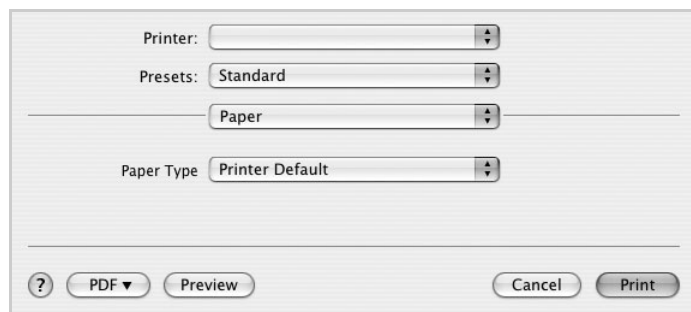

▲ Mac OS 10.4

Printer Features

This tab provides options for selecting the paper type and adjusting print quality. Select **Printer Features** from the **Presets**' drop-down list to access the following features:

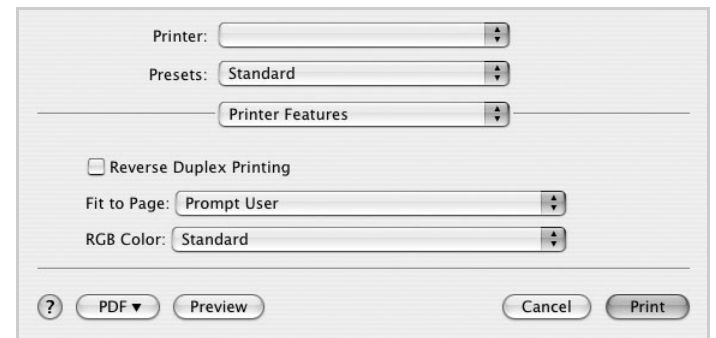

▲ Mac OS 10.4

- **Reverse Duplex Printing**: Allows you to select general print order compare to duplex print order. *If this option does not appear, your printer does not have this feature.*
- **Fit to Page**: This setting allows you to scale your print job to any selected paper size regardless of the digital document size. This can be useful when you want to check fine details on a small document.
- **RGB Color**: This setting determines how colors are rendered. **Standard** is the most widely used setting which the color tone of this mode is the closest to that of standard monitor (sRGB Monitor). **Vivid** mode is appropriate for printing presentation data and charts. The color tone of Vivid mode produces more **Vivid** color images than that of Standard mode. **Device** mode is best used for printing fine lines, small characters and color drawings. The color tone of **Device** mode may be different from that of monitor, the pure toner colors are used for printing Cyan, Magenta and Yellow colors.

Printing Multiple Pages on One Sheet of Paper

You can print more than one page on a single sheet of paper. This feature provides a cost-effective way to print draft pages.

- 1 From your Macintosh application, select **Print** from the **File** menu.
- 2 Select **Layout**.

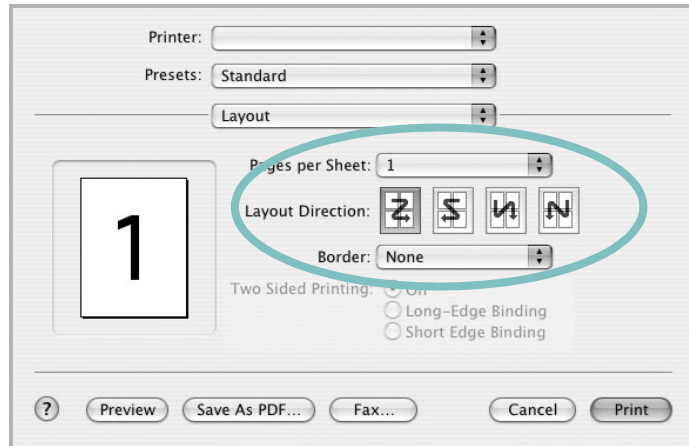

▲ Mac OS 10.3

- 3 Select the number of pages you want to print on one sheet of paper on the **Pages per Sheet** drop-down list.
- 4 Select the page order from the **Layout Direction** option. To print a border around each page on the sheet, select the option you want from the **Border** drop-down list.
- 5 Click **Print**, and the printer prints the selected number of pages on one side of each page.

Duplex Printing

You can print on both sides of the paper. Before printing in the duplex mode, decide on which edge you will be binding your finished document. The binding options are:

- Long-Edge Binding:** Which is the conventional layout used in book binding.
- Short-Edge Binding:** Which is the type often used with calendars.

- 1 From your Macintosh application, select **Print** from the **File** menu.
- 2 Select the **Layout**.

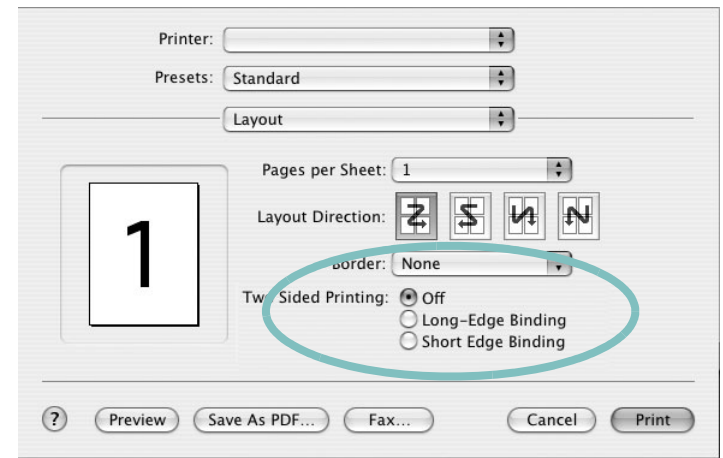

▲ Mac OS 10.3

- 3 Select a binding orientation from **Two Sided Printing** option.
- 4 Click **Print** and the printer prints on both sides of the paper.

CAUTION: If you have selected duplex printing and then try to print multiple copies of a document, the printer may not print the document in the way you want. In case of "Collated copy", if your document has odd pages, the last page of the first copy and the first page of the next copy will be printed on the front and back of one sheet. In case of "Uncollated copy", the same page will be printed on the front and back of one sheet. Therefore, if you need multiple copies of a document and you want those copies on both sides of the paper, you must print them one at a time, as separate print jobs.

Scanning

You can scan documents using **Image Capture** program. Macintosh OS offers **Image Capture** program.

Scanning with USB

- 1 Make sure that your machine and computer are turned on and properly connected to each other.
- 2 Place a single document face down on the document glass. OR load the document(s) face up into the DADF.
- 3 Start **Applications** and click **Image Capture**.

NOTE: If **No Image Capture device connected** message appears, disconnect the USB cable and reconnect it. If the problem persists, please refer to the **Image Capture's** help.

- 4 Set the scan options on this program.
- 5 Scan and save your scanned image.

NOTE:

- For more information about using **Image Capture**, please refer to the **Image Capture's** help.
 - If you want to scan via the DADF, use TWAIN-compliant softwares.
 - You can also scan using TWAIN-compliant softwares, such as Adobe Photoshop.
 - Scan process differ according to TWAIN-compliant softwares. Please refer to the user's guide of the software.
 - If scanning does not operate in **Image Capture**, update Mac OS to the latest version. **Image Capture** operates properly in Mac OS 10.3.9 or higher and Mac OS 10.4.7 or higher.
-

Scanning with network

- 1 Make sure that your machine and computer are turned on.
- 2 Place a single document face down on the document glass. OR load the document(s) face up into the DADF.
- 3 Start **Applications** and click **Image Capture**.
- 4 Click **Devices** and click **Browse Devices**.
- 5 For MAC OS X 10.4:
Select your machine in **Twain devices** option. Make sure that **Use TWAIN software** checkbox is checked, and click **Connect**.

For MAC OS X 10.5:

Make sure that **Connected** checkbox is checked beside your machine in **Bonjour Devices**.

If you want to scan using TWAIN, refer to the MAC OS X 10.4 procedure above.

- 6 Set the scan options on this program.
- 7 Scan and save your scanned image.

NOTE:

- If you want to scan via the DADF, use TWAIN-compliant softwares.
 - For more information about using **Image Capture**, please refer to the **Image Capture's** help.
 - You can also scan using TWAIN-compliant softwares, such as Adobe Photoshop.
 - Scan process differ according to TWAIN-compliant softwares. Please refer to the user's guide of the software.
 - If scanning does not operate in **Image Capture**, update Mac OS to the latest version. **Image Capture** operates properly in Mac OS 10.3.9 or higher and Mac OS 10.4.7 or higher.
-

Setting scan information in Scan Manager.

You can find out about **Scan Manager** program information and installed scan driver's condition. Also, you can change scan settings and add or delete the folders where scanned documents to computer are save in **Scan Manager** program.

- 1 Open **Scan Manager** in **Smart Panel** menu on Status bar.
- 2 **Set Scan Button** allows you to change the saving destination and scan settings, add or delete application program and format files. You can change the scanning machine by using **Change port**. (Local or Network)
- 3 Press **OK** after setting is done.

SOFTWARE SECTION

INDEX

A

advanced printing, use 19

B

booklet printing 20

C

canceling
 scan 29
Color 17

D

document, print
 Macintosh 44
 Windows 14
double-sided printing 21

E

Extras properties, set 17

F

favorites settings, use 18

G

Graphics 17
Graphics properties, set 17

H

help, use 18, 24

I

install
 printer driver
 Macintosh 41, 42
 Windows 5

installing
 Linux software 32

L

Layout properties, set
 Windows 15
Linux
 driver, install 32
 orientation, print 38
 paper size, set
 print 38
 paper source, set 38
 paper type, set
 print 38
 print resolution 38
 printer properties 37
 printing 37
 resolution
 printing 38
 scanning 38

M

Macintosh
 driver
 install 41, 42
 uninstall 41
 printing 44
 scanning 47
 setting up the printer 42
MFP driver, install
 Linux 32

N

n-up printing
 Macintosh 46
 Windows 19

O

orientation, print
 Windows 15

overlay
 create 23
 delete 23
 print 23

P

Paper properties, set 16
paper size, set 16
paper source, set
 Windows 16
paper tray, set
 copy 25
poster, print 20
PostScript driver
 installing 24
print
 document 14
 fit to page 21
 from Macintosh 44
 from Windows 14
 N-up
 Macintosh 46
 Windows 19
 overlay 23
 PRN 14
 scaling 21
 watermark 22
printer driver, install
 Linux 32
printer properties
 Linux 37
printer properties, set
 Macintosh 44
 Windows 15, 24
printer resolution, set
 Windows 17
printer software
 install
 Macintosh 41
 Windows 5
 uninstall
 Macintosh 41
 Windows 12
printing

- booklets 20
- double-sided 21
- from Linux 37

S

- scanning
 - Linux 38
 - SmarThru 27
 - TWAIN 29
 - WIA driver 29
- scanning from Macintosh 47
- setting
 - advanced option 17
 - color mode 17
 - darkness 17
 - favorites 18
 - resolution
 - Windows 17
- software
 - install
 - Macintosh 41, 42
 - Windows 5
 - reinstall
 - Windows 11
 - system requirements
 - Macintosh 41, 42
 - uninstall
 - Macintosh 41
 - Windows 12
- status monitor, use 30

T

- TWAIN, scan 29

U

- uninstall, software
 - Macintosh 41
 - Windows 12
- uninstalling
 - MFP driver
 - Linux 33
- Using 22

W

- watermark
 - create 22
 - delete 22
 - edit 22
 - print 22
- WIA, scan 29